















# Contents

1,2 Contents  
 3,4,5,6 Introduction  
 7,8 Mix & Match  
 9,10 Wall Panels  
 11 Plaid, Ridge, Bold  
 12 Plaid  
  
 13 Ridge  
  
 14 Bold  
  
 15 Moon, Saturn, Venus  
 16 Moon  
  
 17 Saturn  
  
 18 Venus  
  
 19,20 Zig, Zag  
 21 Zig  
  
 22 Zag  
  
 23,24 Corner, Central  
 25 Corner  
  
 26 Central  
  
 27,28 Cross  

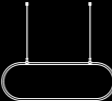
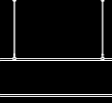
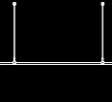
29 Hex-One  
 30 Hex-One  
  
 31 Onyxa  
 32 Onyxa Form  
  
 33 Onyxa Trio  
  
 34 Onyxa Duo  
  
 35,36 Woody Felt  
 37,38 Woody Small  
  
 39,40 Striped  
 41,42 Striped Large  
  
 43,44,45,46 Drop-In Tiles  
 47 Cross Drop-In  
  
 48 CTRL-N  
  
 49 Nest-In  
  
 50 Sonicdome  

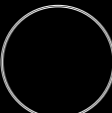
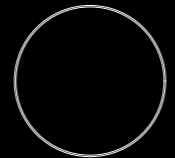
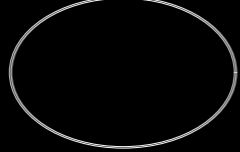
51,52 Sound Blades  
 53,54,55,56 Blade Small  
  
 57,58,59,60 Blade Medium  
  
 61,62,63,64 Blade Medium  
  
 65,66,67,68 Sound Clouds  
 69,70 Rotund Small  
  
 71,72 Rotund Medium  
  
 73,74 Rotund Large  
  
 75,76 Coleo Large  

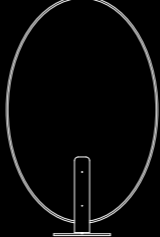
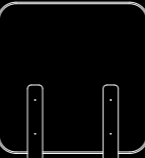
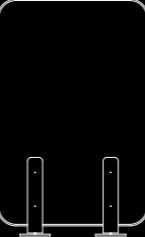
77,78,79,80 Sound Clouds  
 81,82 Oblong Small  
  
 83,84 Frame Large  
  
 85,86 Oblong Large  
  
 87,88,89,90 Dividers  
 91,92 Rotund L - Divider  
  
 93,94 Coleo L - Divider  
  
 95,96 Frame L - Divider  
  
 97,98 Frame L - Divider  

99,100 Accesories  
 101,102 Color-IT  
 103,104 General Conditions for Sales  
 105 General Terms & Conditions  
 106 Acoust-It

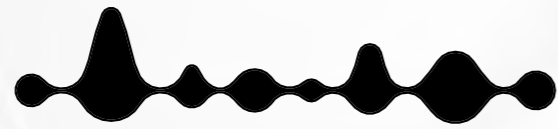

At Acoust-It, we combine artful design, eco-friendly innovation, and acoustic expertise to craft beautifully sustainable solutions for quieter, more harmonious, and efficient spaces.

### Advanced Sound-Absorbing, Accessible Comfort

Our high-performing sound-absorbing products are easy to install and offer a seamless way to create a peaceful and comfortable environment that promotes productivity, relaxation, and overall happiness.

Say goodbye to noise distractions and hello to tranquility.

## Certified Excellence



Flame Resistant  
US: ASTM 84 A Class

EU: B-s1,d0 (EN 13501-1)



%60 Recycled content



%100 Recyclable



Low VOC  
Emission free  
Odorless



Non-Toxic No Chemicals



99.9% Antibacterial  
test (ISO-20743:2013)



Does Not Hold Moisture



Durable



Light fastness 4+  
(ISO-105 B02)



Thermal insulation  
0,035 W/mK



Easy to Clean



# Acoust-It's Felt

Sound Absorbing  
Flame Resistant  
Moisture Regulating  
Heat Accumulating

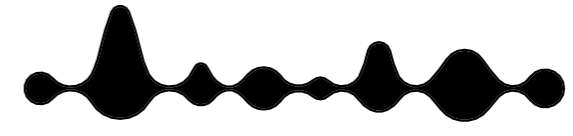

Our excellence is proven through rigorous testing and certification.

Our products offer certified noise cancellation, fire ratings, thermal insulation, antibacterial properties, moisture absorption, and light fastness, ensuring maximum safety and peace of mind.

## Pluffy-Felt: Puffy & Fluffy

Our proprietary porous felted material boasts enhanced air permeability, delivering not only superior acoustic performance, but also exceptional thermal insulation properties.

Acoust-It's pluffy surface excels at sound absorption... and more.

## Eco-Care at Our Core

We prioritize eco-conscious practices in every aspect of our operations, from sourcing raw materials to product disposal.

Our innovative manufacturing techniques reduce waste and energy consumption, while our commitment to sustainability ensures responsible product lifecycle management.

We continuously strive to improve efficiency, reduce energy consumption, target bio-compatibility, and driving towards a greener future.



Join us in making  
eco-friendly choices  
without compromising  
on style or performance.

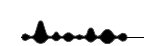



## Stylish and Versatile

Our products are like Lego parts, allowing you to mix and match to your heart's content.

With a wide range of colors, patterns, and customizable options, our PET-Felt panels seamlessly integrate into your interior, adding both beauty and functionality.

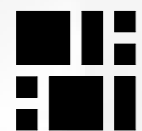

Compatible Variety  
of Standard Sizes



Pinnable



Impact Resistant  
Flexible



Lightweight

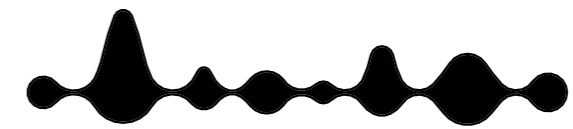

## Mix & Match





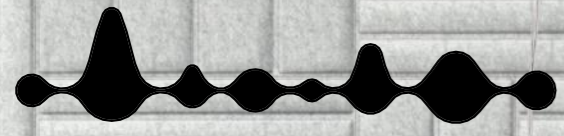

# Wall Panels







# Plaid, Ridge & Bold

## Holistic Aesthetic Appeal

The simple yet cohesive geometry of the Plaid, Ridge, and Bold models allows for versatile use as focal points or backdrops in architectural solutions.

This coordinated grouping enhances holistic aesthetic appeal, optimizing both visual and user experiences to create silent, functional, and visually appealing spaces.



# Plaid

Sound-Absorbing Decorative Panel  
300mm x 300mm x 13mm

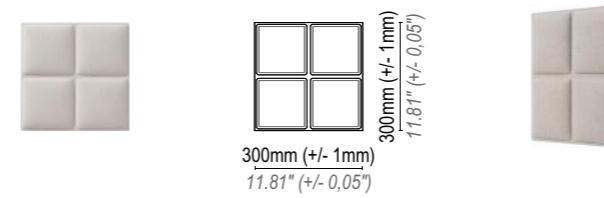

PRODUCT CODE / DESCRIPTION	Box Qty / m <sup>2</sup>	Inherent Colors	Color-IT Custom Colors	Peel & Stick (Optional)
PLD-20AAN - Inherent Colors (Panel Only)	48 / 4.32 m <sup>2</sup>			
PLD-20PSN - Inherent Colors + Peel & Stick	48 / 4.32 m <sup>2</sup>			
PLD-20AAC - Color-IT (Panel Only)	48 / 4.32 m <sup>2</sup>			
PLD-20PSC - Color-IT + Peel & Stick	48 / 4.32 m <sup>2</sup>			

**APPLICATION**  
Wall & Ceiling - Indoor use only

**MATERIAL**  
Mechanical needled punch industrial felt.  
100% PET up to 60% Recycled content & Recyclable



**FIRE RATING**  
A Class (ASTM E84) - B s1 d0 (EN 13501-1)

**THERMAL INSULATION**  
0,035 W/mK

**WEIGHT**  
1 tile: 112.5 gr. +/- 10% tolerance  
1 tile: 0.25 lbs with +/- 10% tolerance

**THICKNESS**  
Max. 13 mm (+/- 2 mm) - 0.51\"/>

**BOX SIZE & CONTENT**  
W: 620 mm D: 660 mm H: 190 mm  
W: 24.5\"/>

### PALETTE SIZE & CONTENT

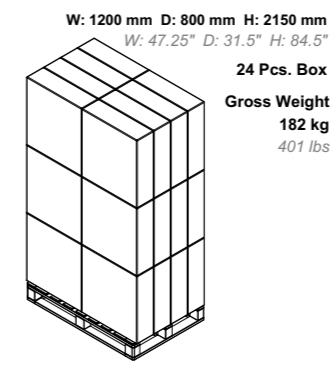
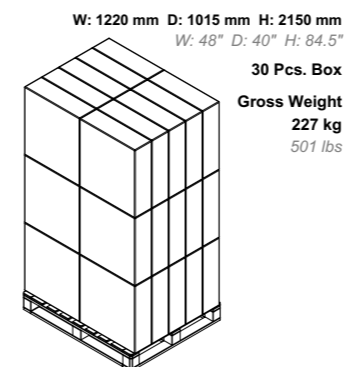

### ACOUSTIC PERFORMANCE

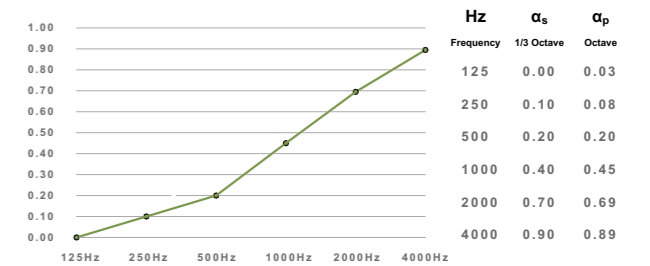

	α <sub>w</sub>	NRC	SAA	Class
According to ISO 11654   According to ASTM C423   Sound Absorption Average   Sound Absorption				
Plaid	0.25	0.40	0.36	E

α<sub>w</sub> Sound absorption coefficient according to ISO 354 α<sub>p</sub> Practical sound absorption coefficient according to ISO 11654



# Ridge Sound-Absorbing Decorative Panel

300mm x 600mm x 13mm

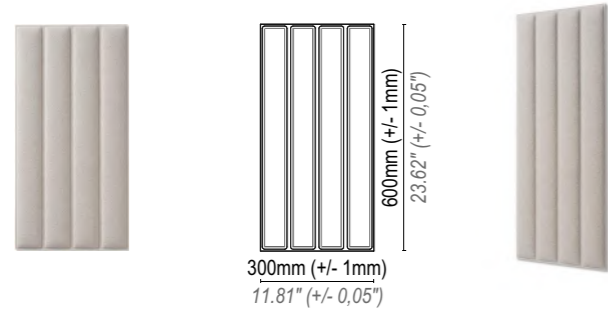

	Inherent Colors	Color-IT Custom Colors	Peel & Stick (Optional)
<b>PRODUCT CODE / DESCRIPTION</b>			
<b>Box Qty / m<sup>2</sup></b>			
RDG-20AAN - Inherent Colors (Panel Only)			
RDG-20PSN - Inherent Colors + Peel & Stick			
RDG-20AAC - Color-IT (Panel Only)			
RDG-20PSC - Color-IT + Peel & Stick			

**APPLICATION**  
Wall & Ceiling - Indoor use only

**MATERIAL**  
Mechanical needled punch industrial felt.  
100% PET up to 60% Recycled content & Recyclable

Smooth Surface - Impact Resistance - Flexible

**FIRE RATING**  
A Class (ASTM E84) - B s1 d0 (EN 13501-1)

**THERMAL INSULATION**  
0,035 W/mK

**WEIGHT**  
1 tile: 225 gr. +/- 10% tolerance  
1 tile: 0.50 lbs with +/- 10% tolerance

**THICKNESS**  
 Max. 13 mm (+/- 2 mm) - 0.51" (+/-0.08")  
Min. 3 mm (+/- 2 mm) - 0.12" (+/-0.08")

**BOX SIZE & CONTENT**  
W: 620 mm D: 660 mm H: 190 mm  
W: 24.5" D: 26" H: 7.5"

**1 Box: 24 x panels**  
1 Box: 4.32 m<sup>2</sup>  
1 Box: 46.50 ft<sup>2</sup>  
**1 Color of choice per package**  
Gross weight: 6.8 kg  
Gross weight: 15 lbs

**PALETTE SIZE & CONTENT**

W: 1220 mm D: 1015 mm H: 2150 mm  
W: 48" D: 40" H: 84.5"  
**30 Pcs. Box**  
Gross Weight **227 kg**  
501 lbs

W: 1200 mm D: 800 mm H: 2150 mm  
W: 47.25" D: 31.5" H: 84.5"  
**24 Pcs. Box**  
Gross Weight **182 kg**  
401 lbs

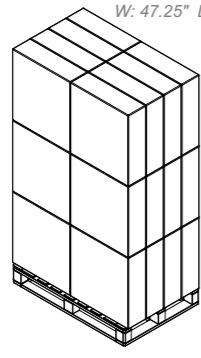
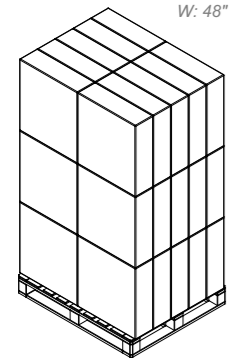

**ACOUSTIC PERFORMANCE**

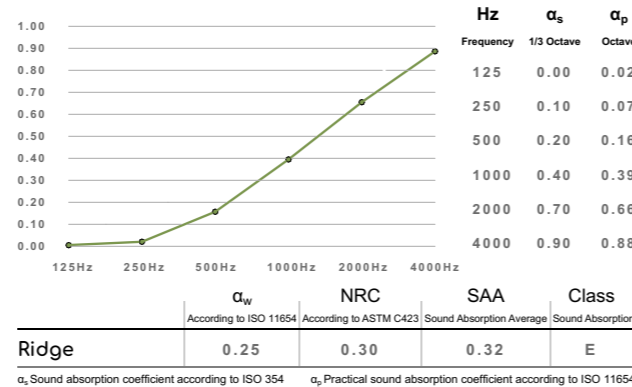

# Bold Sound-Absorbing Decorative Panel

600mm x 600mm x 13mm

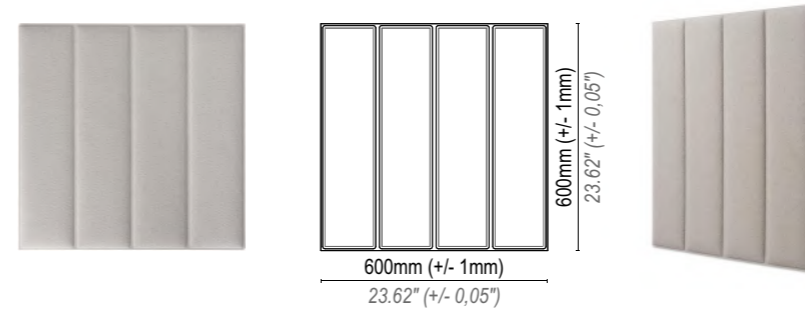

	Inherent Colors	Color-IT Custom Colors	Peel & Stick (Optional)
<b>PRODUCT CODE / DESCRIPTION</b>			
<b>Box Qty / m<sup>2</sup></b>			
BLD-20AAN - Inherent Colors (Panel Only)			
BLD-20PSN - Inherent Colors + Peel & Stick			
BLD-20AAC - Color-IT (Panel Only)			
BLD-20PSC - Color-IT + Peel & Stick			

**APPLICATION**  
Wall & Ceiling - Indoor use only

**MATERIAL**  
Mechanical needled punch industrial felt.  
100% PET up to 60% Recycled content & Recyclable

Smooth Surface - Impact Resistance - Flexible

**FIRE RATING**  
A Class (ASTM E84) - B s1 d0 (EN 13501-1)

**THERMAL INSULATION**  
0,035 W/mK

**WEIGHT**  
1 tile: 450 gr. +/- 10% tolerance  
1 tile: 1 lb with +/- 10% tolerance

**THICKNESS**  
 Max. 13 mm (+/- 2 mm) - 0.51" (+/-0.08")  
Min. 3 mm (+/- 2 mm) - 0.12" (+/-0.08")

**BOX SIZE & CONTENT**  
W: 620 mm D: 660 mm H: 190 mm  
W: 24.5" D: 26" H: 7.5"

**1 Box: 12 x panels**  
1 Box: 4.32 m<sup>2</sup>  
1 Box: 46.50 ft<sup>2</sup>  
**1 Color of choice per package**  
Gross weight: 6.8 kg  
Gross weight: 15 lbs

**PALETTE SIZE & CONTENT**

W: 1220 mm D: 1015 mm H: 2150 mm  
W: 48" D: 40" H: 84.5"  
**30 Pcs. Box**  
Gross Weight **227 kg**  
501 lbs

W: 1200 mm D: 800 mm H: 2150 mm  
W: 47.25" D: 31.5" H: 84.5"  
**24 Pcs. Box**  
Gross Weight **182 kg**  
401 lbs

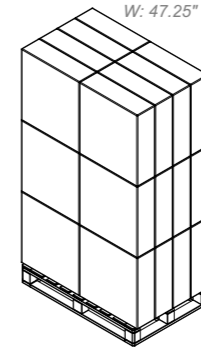
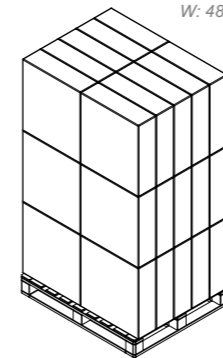

**ACOUSTIC PERFORMANCE**

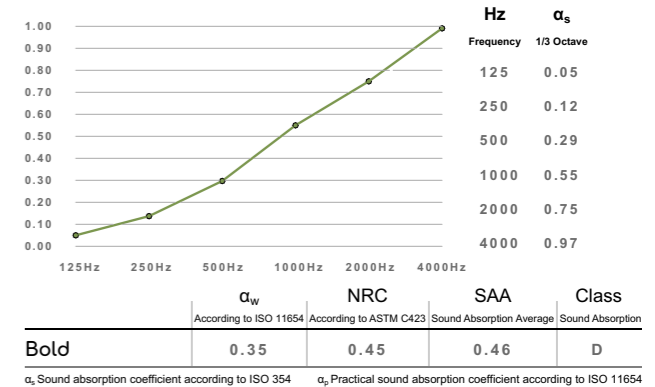





# Moon, Saturn & Venus

## Celestial Harmonious Design

Inspired by celestial bodies, our circular-designed product group-featuring the 'Moon, Saturn, and Venus' models-enhances acoustic balance in spaces.

These models, drawing from the natural geometries of planets, work harmoniously to optimize acoustics.

Incorporating these design-focused pieces balances visual and auditory elements, creating an immersive and harmonious environment.



# Moon

Sound-Absorbing Decorative Panel

300mm x 300mm x 13mm

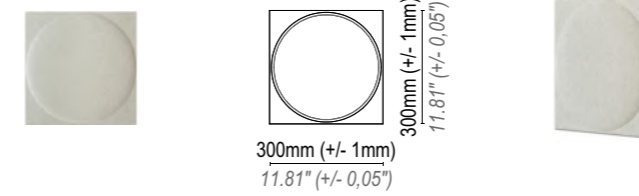

PRODUCT CODE / DESCRIPTION	Box Qty / m <sup>2</sup>	Inherent Colors	Color-IT Custom Colors	Peel & Stick (Optional)
		MON-20AAN - Inherent Colors (Panel Only)	48 / 4.32 m <sup>2</sup>	
MON-20PSN - Inherent Colors + Peel & Stick	48 / 4.32 m <sup>2</sup>			
MON-20AAC - Color-IT (Panel Only)	48 / 4.32 m <sup>2</sup>			
MON-20PSC - Color-IT + Peel & Stick	48 / 4.32 m <sup>2</sup>			

### APPLICATION

Wall & Ceiling - Indoor use only

### MATERIAL

Mechanical needled punch industrial felt.  
100% PET up to 60% Recycled content & Recyclable



Smooth Surface - Impact Resistance - Flexible

### FIRE RATING

A Class (ASTM E84) - B s1 d0 (EN 13501-1)

### THERMAL INSULATION

0,035 W/mK

### WEIGHT

1 tile: 112.5 gr. +/- 10% tolerance  
1 tile: 0.25 lbs with +/- 10% tolerance

### THICKNESS

Max. 13 mm (+/- 2 mm) - 0.51" (+/-0.08")  
Min. 3 mm (+/- 2 mm) - 0.12" (+/-0.08")

### BOX SIZE & CONTENT

W: 620 mm D: 660 mm H: 190 mm  
W: 24.5" D: 26" H: 7.5"

1 Box: 48 x panels

1 Box: 4.32 m<sup>2</sup>

1 Box: 46.50 ft<sup>2</sup>

1 Color of choice per package

Gross weight: 6.8 kg

Gross weight: 15 lbs

### PALETTE SIZE & CONTENT

W: 1220 mm D: 1015 mm H: 2150 mm  
W: 48" D: 40" H: 84.5"

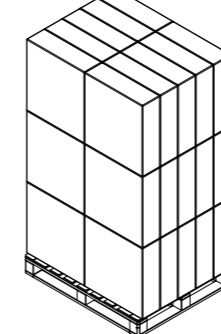

30 Pcs. Box  
Gross Weight  
227 kg  
501 lbs

W: 1200 mm D: 800 mm H: 2150 mm  
W: 47.25" D: 31.5" H: 84.5"

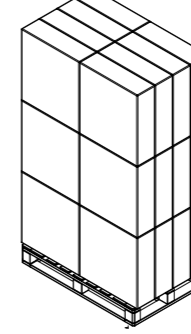

24 Pcs. Box  
Gross Weight  
182 kg  
401 lbs



### ACOUSTIC PERFORMANCE

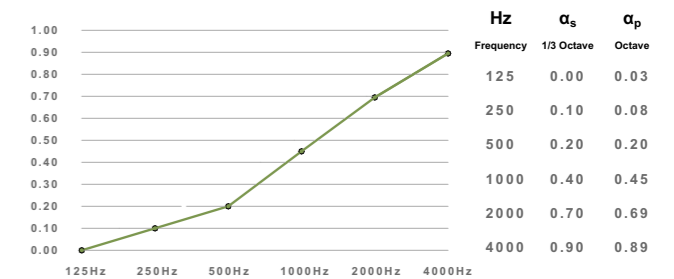

	$\alpha_w$	NRC	SAA	Class
Reference Product: Plaid				
According to ISO 11654		According to ASTM C423	Sound Absorption Average	Sound Absorption
<b>Moon</b>	0.25	0.40	0.36	E

$\alpha_s$  Sound absorption coefficient according to ISO 354  $\alpha_p$  Practical sound absorption coefficient according to ISO 11654





# Saturn

Sound-Absorbing Decorative Panel

600mm x 600mm x 13mm

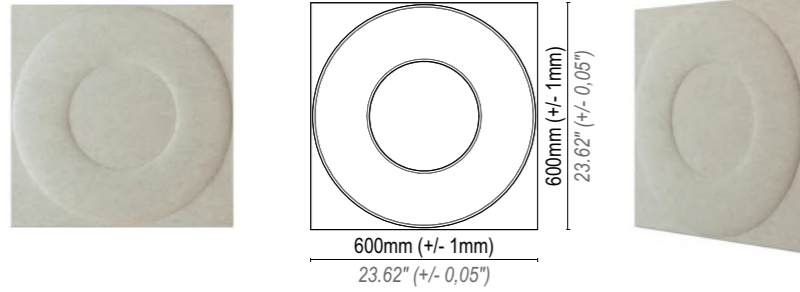

PRODUCT CODE / DESCRIPTION	Box Qty / m <sup>2</sup>	Inherent Colors			Color-IT Custom Colors												Peel & Stick (Optional)				
		Pearl White	Mist	Dark Grey	White	Light Green	Dark Green	Sky Blue	Violet	Pink	Light Purple	Dark Purple	Red	Orange	Yellow	Light Blue	Dark Blue	Black	Grey	White	
STN-20AAN - Inherent Colors (Panel Only)	12 / 4.32 m <sup>2</sup>																				
STN-20PSN - Inherent Colors + Peel & Stick	12 / 4.32 m <sup>2</sup>																				
STN-20AAC - Color-IT (Panel Only)	12 / 4.32 m <sup>2</sup>																				
STN-20PSC - Color-IT + Peel & Stick	12 / 4.32 m <sup>2</sup>																				

**APPLICATION**  
Wall & Ceiling - Indoor use only

**MATERIAL**  
Mechanical needled punch industrial felt.  
100% PET up to 60% Recycled content & Recyclable

**Smooth Surface - Impact Resistance - Flexible**

**FIRE RATING**  
A Class (ASTM E84) - B s1 d0 (EN 13501-1)

**THERMAL INSULATION**  
0,035 W/mK

**WEIGHT**  
1 tile: 450 gr. +/- 10% tolerance  
1 tile: 1 lb with +/- 10% tolerance

**THICKNESS**  
Max. 13 mm (+/- 2 mm) - 0.51" (+/-0.08")  
Min. 3 mm (+/- 2 mm) - 0.12" (+/-0.08")

**BOX SIZE & CONTENT**  
W: 620 mm D: 660 mm H: 190 mm  
W: 24.5" D: 26" H: 7.5"

**1 Box: 12 x panels**  
1 Box: 4.32 m<sup>2</sup>  
1 Box: 46.50 ft<sup>2</sup>  
**1 Color of choice per package**  
Gross weight: 6.8 kg  
Gross weight: 15 lbs



**PALETTE SIZE & CONTENT**

W: 1220 mm D: 1015 mm H: 2150 mm  
W: 48" D: 40" H: 84.5"  
**30 Pcs. Box**  
Gross Weight  
227 kg  
501 lbs

W: 1200 mm D: 800 mm H: 2150 mm  
W: 47.25" D: 31.5" H: 84.5"  
**24 Pcs. Box**  
Gross Weight  
182 kg  
401 lbs

**ACOUSTIC PERFORMANCE**

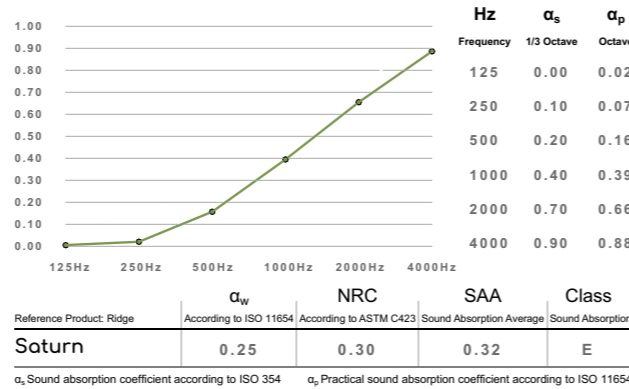

# Venus

Sound-Absorbing Decorative Panel

600mm x 600mm x 13mm

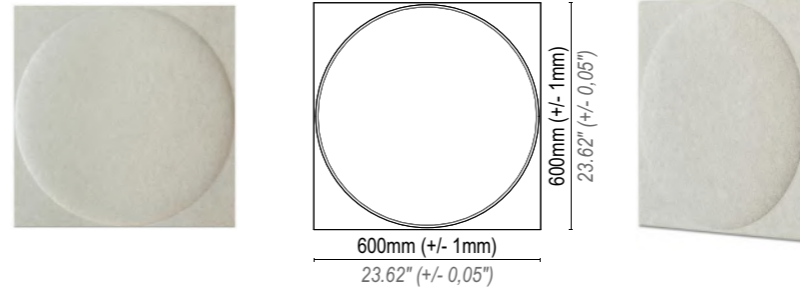

PRODUCT CODE / DESCRIPTION	Box Qty / m <sup>2</sup>	Inherent Colors			Color-IT Custom Colors												Peel & Stick (Optional)				
		Pearl White	Mist	Dark Grey	White	Light Green	Dark Green	Sky Blue	Violet	Pink	Light Purple	Dark Purple	Red	Orange	Yellow	Light Blue	Dark Blue	Black	Grey	White	
VNS-20AAN - Inherent Colors (Panel Only)	12 / 4.32 m <sup>2</sup>																				
VNS-20PSN - Inherent Colors + Peel & Stick	12 / 4.32 m <sup>2</sup>																				
VNS-20AAC - Color-IT (Panel Only)	12 / 4.32 m <sup>2</sup>																				
VNS-20PSC - Color-IT + Peel & Stick	12 / 4.32 m <sup>2</sup>																				

**APPLICATION**  
Wall & Ceiling - Indoor use only

**MATERIAL**  
Mechanical needled punch industrial felt.  
100% PET up to 60% Recycled content & Recyclable

**Smooth Surface - Impact Resistance - Flexible**

**FIRE RATING**  
A Class (ASTM E84) - B s1 d0 (EN 13501-1)

**THERMAL INSULATION**  
0,035 W/mK

**WEIGHT**  
1 tile: 450 gr. +/- 10% tolerance  
1 tile: 1 lb with +/- 10% tolerance

**THICKNESS**  
Max. 13 mm (+/- 2 mm) - 0.51" (+/-0.08")  
Min. 3 mm (+/- 2 mm) - 0.12" (+/-0.08")

**BOX SIZE & CONTENT**  
W: 620 mm D: 660 mm H: 190 mm  
W: 24.5" D: 26" H: 7.5"

**1 Box: 12 x panels**  
1 Box: 4.32 m<sup>2</sup>  
1 Box: 46.50 ft<sup>2</sup>  
**1 Color of choice per package**  
Gross weight: 6.8 kg  
Gross weight: 15 lbs



**PALETTE SIZE & CONTENT**

W: 1220 mm D: 1015 mm H: 2150 mm  
W: 48" D: 40" H: 84.5"  
**30 Pcs. Box**  
Gross Weight  
227 kg  
501 lbs

W: 1200 mm D: 800 mm H: 2150 mm  
W: 47.25" D: 31.5" H: 84.5"  
**24 Pcs. Box**  
Gross Weight  
182 kg  
401 lbs

**ACOUSTIC PERFORMANCE**

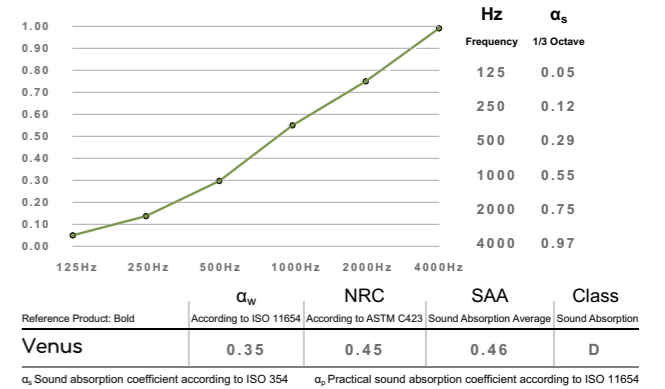





## Zig, Zag

Movement & Acoustic Comfort

The 'Zig' and 'Zag' models move in contrasting directions yet integrate seamlessly with the 'Bold' model, creating a perfect combination within the Acoust-It range.

This coordinated collection provides aesthetic appeal and acoustic comfort for interiors."







# Zig Sound-Absorbing Decorative Panel

600mm x 600mm x 13mm

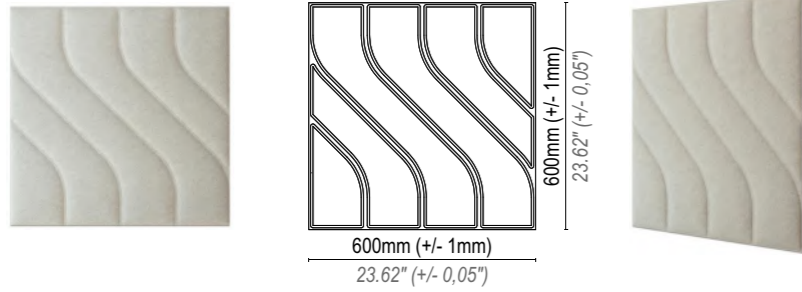

PRODUCT CODE / DESCRIPTION	Box Qty / m <sup>2</sup>	Inherent Colors			Color-IT Custom Colors												Peel & Stick (Optional)		
		Pearl White	Mist	Dark Grey	White	Lemon	Olive Green	Sky Blue	Violet	Pink Lavender	Yellow	Blue	Orange	Red	Green	Black	Grey	Black	Sand
ZIG-20AAN - Inherent Colors (Panel Only)	12 / 4.32 m <sup>2</sup>																		
ZIG-20PSN - Inherent Colors + Peel & Stick	12 / 4.32 m <sup>2</sup>																		
ZIG-20AAC - Color-IT (Panel Only)	12 / 4.32 m <sup>2</sup>																		
ZIG-20PSC - Color-IT + Peel & Stick	12 / 4.32 m <sup>2</sup>																		

**APPLICATION**  
Wall & Ceiling - Indoor use only

**MATERIAL**  
Mechanical needled punch industrial felt.  
100% PET up to 60% Recycled content & Recyclable



**FIRE RATING**  
A Class (ASTM E84) - B s1 d0 (EN 13501-1)

**THERMAL INSULATION**  
0,035 W/mK

**WEIGHT**  
1 tile: 450 gr. +/- 10% tolerance  
1 tile: 1 lb with +/- 10% tolerance

**THICKNESS**  
Max. 13 mm (+/- 2 mm) - 0.51" (+/- 0.08")  
Min. 3 mm (+/- 2 mm) - 0.12" (+/- 0.08")

**BOX SIZE & CONTENT**  
W: 620 mm D: 660 mm H: 190 mm  
W: 24.5" D: 26" H: 7.5"

**1 Box: 12 x panels**  
1 Box: 4.32 m<sup>2</sup>  
1 Box: 46.50 ft<sup>2</sup>  
**1 Color of choice per package**  
Gross weight: 6.8 kg  
Gross weight: 15 lbs

**PALETTE SIZE & CONTENT**

W: 1220 mm D: 1015 mm H: 2150 mm  
W: 48" D: 40" H: 84.5"

**30 Pcs. Box**  
Gross Weight **227 kg**  
501 lbs

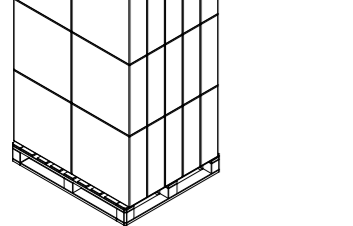

W: 1200 mm D: 800 mm H: 2150 mm  
W: 47.25" D: 31.5" H: 84.5"

**24 Pcs. Box**  
Gross Weight **182 kg**  
401 lbs

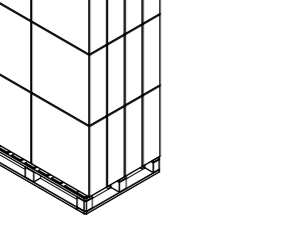

**ACOUSTIC PERFORMANCE**

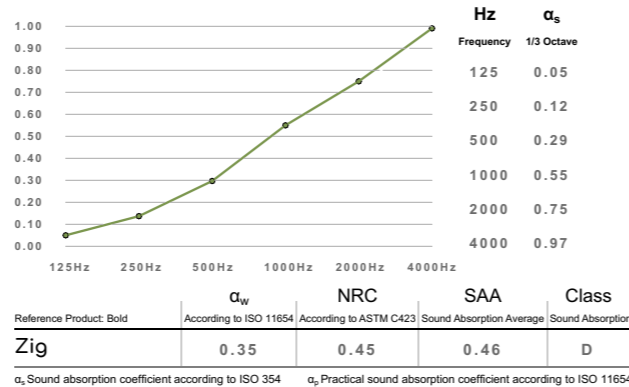

# Zag Sound-Absorbing Decorative Panel

600mm x 600mm x 13mm

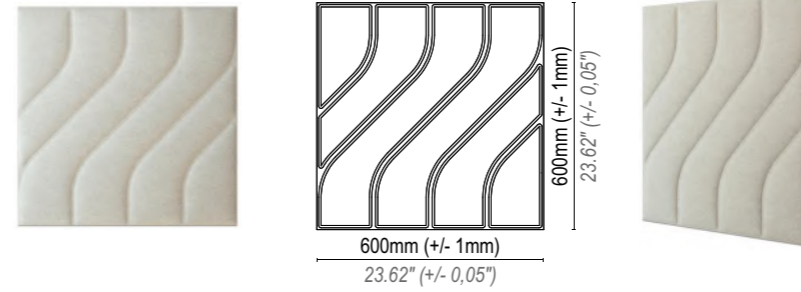

PRODUCT CODE / DESCRIPTION	Box Qty / m <sup>2</sup>	Inherent Colors			Color-IT Custom Colors												Peel & Stick (Optional)		
		Pearl White	Mist	Dark Grey	White	Lemon	Olive Green	Sky Blue	Violet	Pink Lavender	Yellow	Blue	Orange	Red	Green	Black	Grey	Black	Sand
ZAG-20AAN - Inherent Colors (Panel Only)	12 / 4.32 m <sup>2</sup>																		
ZAG-20PSN - Inherent Colors + Peel & Stick	12 / 4.32 m <sup>2</sup>																		
ZAG-20AAC - Color-IT (Panel Only)	12 / 4.32 m <sup>2</sup>																		
ZAG-20PSC - Color-IT + Peel & Stick	12 / 4.32 m <sup>2</sup>																		

**APPLICATION**  
Wall & Ceiling - Indoor use only

**MATERIAL**  
Mechanical needled punch industrial felt.  
100% PET up to 60% Recycled content & Recyclable



**FIRE RATING**  
A Class (ASTM E84) - B s1 d0 (EN 13501-1)

**THERMAL INSULATION**  
0,035 W/mK

**WEIGHT**  
1 tile: 450 gr. +/- 10% tolerance  
1 tile: 1 lb with +/- 10% tolerance

**THICKNESS**  
Max. 13 mm (+/- 2 mm) - 0.51" (+/- 0.08")  
Min. 3 mm (+/- 2 mm) - 0.12" (+/- 0.08")

**BOX SIZE & CONTENT**  
W: 620 mm D: 660 mm H: 190 mm  
W: 24.5" D: 26" H: 7.5"

**1 Box: 12 x panels**  
1 Box: 4.32 m<sup>2</sup>  
1 Box: 46.50 ft<sup>2</sup>  
**1 Color of choice per package**  
Gross weight: 6.8 kg  
Gross weight: 15 lbs

**PALETTE SIZE & CONTENT**

W: 1220 mm D: 1015 mm H: 2150 mm  
W: 48" D: 40" H: 84.5"

**30 Pcs. Box**  
Gross Weight **227 kg**  
501 lbs

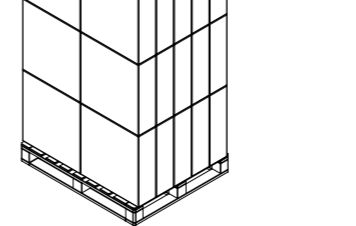

W: 1200 mm D: 800 mm H: 2150 mm  
W: 47.25" D: 31.5" H: 84.5"

**24 Pcs. Box**  
Gross Weight **182 kg**  
401 lbs

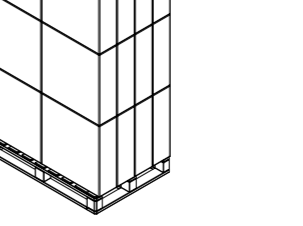

**ACOUSTIC PERFORMANCE**

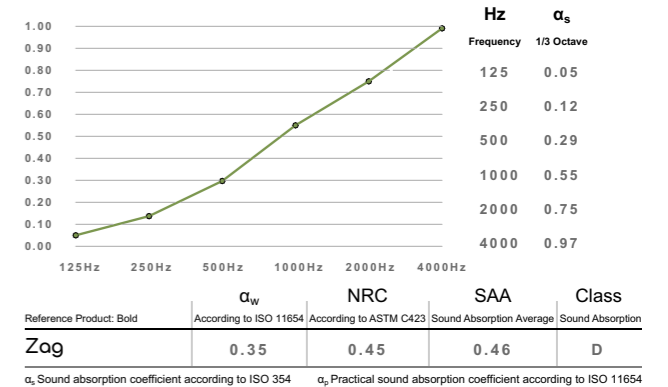





## Corner & Central

Intertwining Waves, Crafting Silence

We've maintained harmony and continuity, creating intertwining waves that blend seamlessly with other products in our series.

This integration allows for the recreation of silent spaces, offering endless customizable options to suit your preferences.

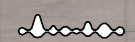





# Corner

Sound-Absorbing Decorative Panel

600mm x 600mm x 13mm

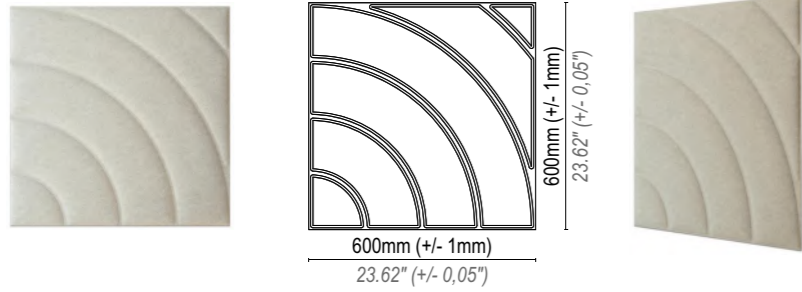

PRODUCT CODE / DESCRIPTION	Box Qty / m <sup>2</sup>	Inherent Colors	Color-IT Custom Colors	Peel & Stick (Optional)
		CRN-20AAN - Inherent Colors (Panel Only)	12 / 4.32 m <sup>2</sup>	
CRN-20PSN - Inherent Colors + Peel & Stick	12 / 4.32 m <sup>2</sup>			
CRN-20AAC - Color-IT (Panel Only)	12 / 4.32 m <sup>2</sup>			
CRN-20PSC - Color-IT + Peel & Stick	12 / 4.32 m <sup>2</sup>			

**APPLICATION**  
Wall & Ceiling - Indoor use only

**MATERIAL**  
Mechanical needled punch industrial felt.  
100% PET up to 60% Recycled content & Recyclable

Smooth Surface - Impact Resistance - Flexible

**FIRE RATING**  
A Class (ASTM E84) - B s1 d0 (EN 13501-1)

**THERMAL INSULATION**  
0,035 W/mK

**WEIGHT**  
1 tile: 450 gr. +/- 10% tolerance  
1 tile: 1 lb with +/- 10% tolerance

**THICKNESS**  
  
Max. 13 mm (+/- 2 mm) - 0.51" (+/-0.08")  
Min. 3 mm (+/- 2 mm) - 0.12" (+/-0.08")

**BOX SIZE & CONTENT**  
W: 620 mm D: 660 mm H: 190 mm  
W: 24.5" D: 26" H: 7.5"

**1 Box: 12 x panels**  
1 Box: 4.32 m<sup>2</sup>  
1 Box: 46.50 ft<sup>2</sup>  
**1 Color of choice per package**  
Gross weight: 6.8 kg  
Gross weight: 15 lbs



### PALETTE SIZE & CONTENT

W: 1220 mm D: 1015 mm H: 2150 mm  
W: 48" D: 40" H: 84.5"  
**30 Pcs. Box**  
Gross Weight  
227 kg  
501 lbs

W: 1200 mm D: 800 mm H: 2150 mm  
W: 47.25" D: 31.5" H: 84.5"  
**24 Pcs. Box**  
Gross Weight  
182 kg  
401 lbs

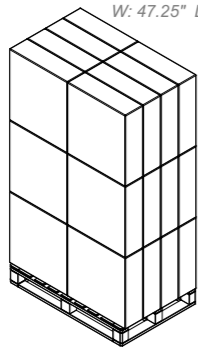
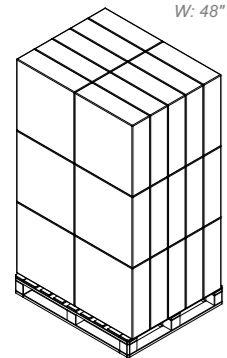

### ACOUSTIC PERFORMANCE

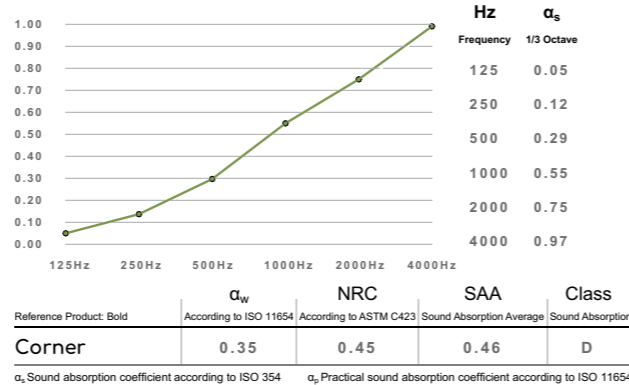

# Central

Sound-Absorbing Decorative Panel

600mm x 600mm x 13mm

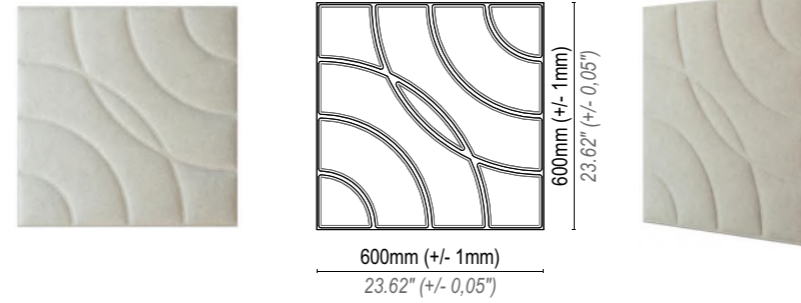

PRODUCT CODE / DESCRIPTION	Box Qty / m <sup>2</sup>	Inherent Colors	Color-IT Custom Colors	Peel & Stick (Optional)
		CNL-20AAN - Inherent Colors (Panel Only)	12 / 4.32 m <sup>2</sup>	
CNL-20PSN - Inherent Colors + Peel & Stick	12 / 4.32 m <sup>2</sup>			
CNL-20AAC - Color-IT (Panel Only)	12 / 4.32 m <sup>2</sup>			
CNL-20PSC - Color-IT + Peel & Stick	12 / 4.32 m <sup>2</sup>			

**APPLICATION**  
Wall & Ceiling - Indoor use only

**MATERIAL**  
Mechanical needled punch industrial felt.  
100% PET up to 60% Recycled content & Recyclable

Smooth Surface - Impact Resistance - Flexible

**FIRE RATING**  
A Class (ASTM E84) - B s1 d0 (EN 13501-1)

**THERMAL INSULATION**  
0,035 W/mK

**WEIGHT**  
1 tile: 450 gr. +/- 10% tolerance  
1 tile: 1 lb with +/- 10% tolerance

**THICKNESS**  
  
Max. 13 mm (+/- 2 mm) - 0.51" (+/-0.08")  
Min. 3 mm (+/- 2 mm) - 0.12" (+/-0.08")

**BOX SIZE & CONTENT**  
W: 620 mm D: 660 mm H: 190 mm  
W: 24.5" D: 26" H: 7.5"

**1 Box: 12 x panels**  
1 Box: 4.32 m<sup>2</sup>  
1 Box: 46.50 ft<sup>2</sup>  
**1 Color of choice per package**  
Gross weight: 6.8 kg  
Gross weight: 15 lbs



### PALETTE SIZE & CONTENT

W: 1220 mm D: 1015 mm H: 2150 mm  
W: 48" D: 40" H: 84.5"  
**30 Pcs. Box**  
Gross Weight  
227 kg  
501 lbs

W: 1200 mm D: 800 mm H: 2150 mm  
W: 47.25" D: 31.5" H: 84.5"  
**24 Pcs. Box**  
Gross Weight  
182 kg  
401 lbs

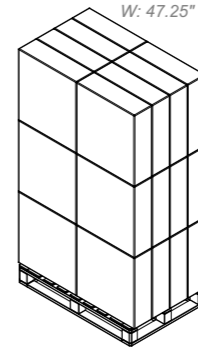
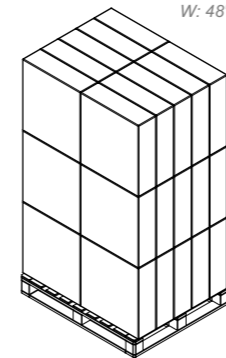

### ACOUSTIC PERFORMANCE

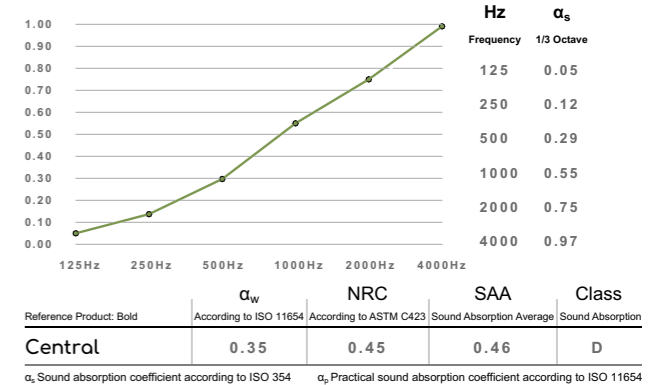





# Cross

## Dynamism and Simplicity

'Cross' features a versatile diagonal line pattern that enables creative installations through simple 90-degree rotations, allowing you to refresh aesthetics without additional patterns.

This functionality not only enhances visual appeal but also offers limitless customization while ensuring consistent acoustic performance.



# Cross

Sound-Absorbing Decorative Panel  
600mm x 600mm x 13mm

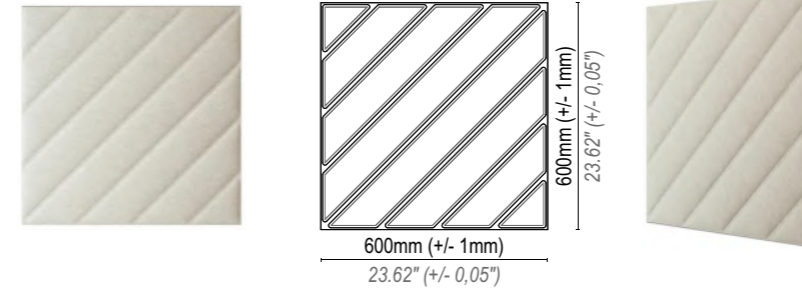

	Inherent Colors	Color-IT Custom Colors	Peel & Stick (Optional)
<b>PRODUCT CODE / DESCRIPTION</b>			
CRS-20AAN - Inherent Colors (Panel Only)	12 / 4.32 m <sup>2</sup>		
CRS-20PSN - Inherent Colors + Peel & Stick	12 / 4.32 m <sup>2</sup>		
CRS-20AAC - Color-IT (Panel Only)	12 / 4.32 m <sup>2</sup>		
CRS-20PSC - Color-IT + Peel & Stick	12 / 4.32 m <sup>2</sup>		

### APPLICATION

Wall & Ceiling - Indoor use only

### MATERIAL

Mechanical needled punch industrial felt.  
100% PET up to 60% Recycled content & Recyclable



Smooth Surface - Impact Resistance - Flexible

### FIRE RATING

A Class (ASTM E84) - B s1 d0 (EN 13501-1)

### THERMAL INSULATION

0,035 W/mK

### WEIGHT

1 tile: 450 gr. +/- 10% tolerance  
1 tile: 1 lb with +/- 10% tolerance

### THICKNESS

Max. 13 mm (+/- 2 mm) - 0.51" (+/-0.08")  
Min. 3 mm (+/- 2 mm) - 0.12" (+/-0.08")

### BOX SIZE & CONTENT

W: 620 mm D: 660 mm H: 190 mm  
W: 24.5" D: 26" H: 7.5"

1 Box: 12 x panels

1 Box: 4.32 m<sup>2</sup>

1 Box: 46.50 ft<sup>2</sup>

1 Color of choice per package

Gross weight: 6.8 kg

Gross weight: 15 lbs

### PALETTE SIZE & CONTENT

W: 1220 mm D: 1015 mm H: 2150 mm  
W: 48" D: 40" H: 84.5"

30 Pcs. Box  
Gross Weight  
227 kg  
501 lbs

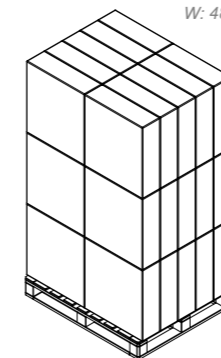

W: 1200 mm D: 800 mm H: 2150 mm  
W: 47.25" D: 31.5" H: 84.5"

24 Pcs. Box  
Gross Weight  
182 kg  
401 lbs

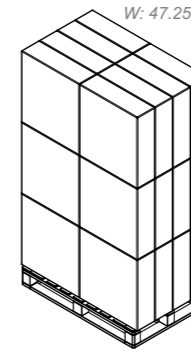

### ACOUSTIC PERFORMANCE

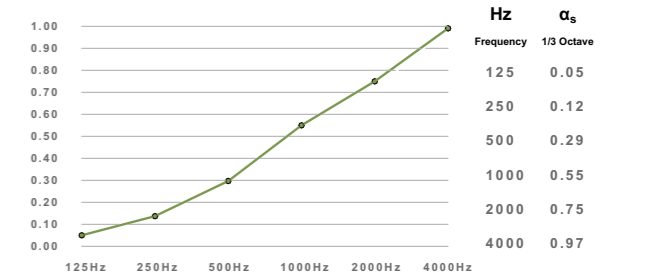

Reference Product: Bold	α <sub>w</sub> According to ISO 11654	NRC According to ASTM C423	SAA Sound Absorption Average	Class Sound Absorption
<b>Cross</b>	0.35	0.45	0.46	D

α<sub>s</sub> Sound absorption coefficient according to ISO 354 α<sub>p</sub> Practical sound absorption coefficient according to ISO 11654







# Hex-One

## Visual Depth and Acoustics

The unique hexagonal designs allow for versatile configurations and tessellation, creating a stunning visual impact while effectively managing sound.

These panels create a striking three-dimensional effect that adds a dynamic and engaging element to both commercial and residential spaces.

Beyond their aesthetic appeal, they effectively manage sound, enhancing acoustic comfort while transforming interiors into visually captivating environments.



# Hex-One

Sound-Absorbing Decorative Panel

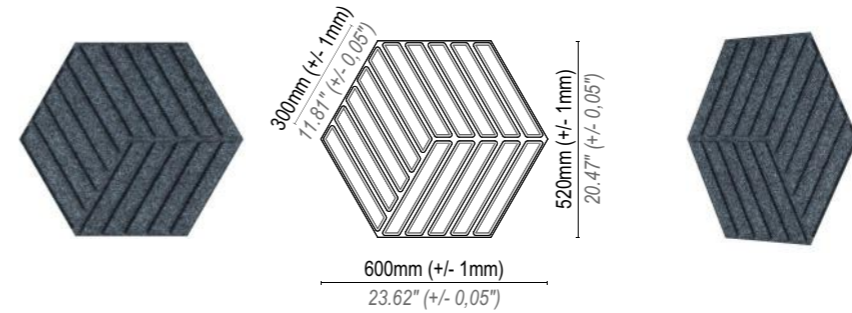

	Inherent Colors	Color-IT Custom Colors	Peel & Stick (Optional)
<b>PRODUCT CODE / DESCRIPTION</b>			
HXO-20AAN - Inherent Colors (Panel Only)			
<b>Box Qty / m<sup>2</sup></b>			
HXO-20PSN - Inherent Colors + Peel & Stick			12 / 3.74 m <sup>2</sup>
HXO-20AAC - Color-IT (Panel Only)			12 / 3.74 m <sup>2</sup>
HXO-20PSC - Color-IT + Peel & Stick			12 / 3.74 m <sup>2</sup>

### APPLICATION

Wall & Ceiling - Indoor use only

### MATERIAL

Mechanical needled punch industrial felt.  
100% PET up to 60% Recycled content & Recyclable



Smooth Surface - Impact Resistance - Flexible

### FIRE RATING

A Class (ASTM E84) - B s1 d0 (EN 13501-1)

### THERMAL INSULATION

0,035 W/mK

### WEIGHT

1 tile: 400 gr. +/- 10% tolerance  
1 tile: 0.88 lbs with +/- 10% tolerance

### THICKNESS

Max. 13 mm (+/- 2 mm) - 0.51" (+/-0.08")  
Min. 3 mm (+/- 2 mm) - 0.12" (+/-0.08")

### BOX SIZE & CONTENT

W: 620 mm D: 660 mm H: 190 mm  
W: 24.5" D: 26" H: 7.5"

1 Box: 12 x panels

1 Box: 3.744 m<sup>2</sup>

1 Box: 40.30 ft<sup>2</sup>

1 Color of choice per package

Gross weight: 6.0 kg

Gross weight: 13.22 lbs

### PALETTE SIZE & CONTENT

W: 1220 mm D: 1015 mm H: 2150 mm  
W: 48" D: 40" H: 84.5"

30 Pcs. Box  
Gross Weight  
210 kg  
463 lbs

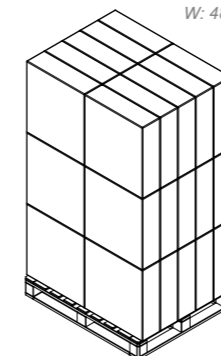

W: 1200 mm D: 800 mm H: 2150 mm  
W: 47.25" D: 31.5" H: 84.5"

24 Pcs. Box  
Gross Weight  
165 kg  
364 lbs

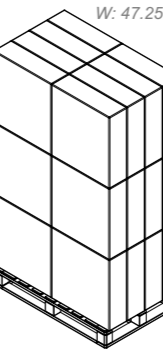

### ACOUSTIC PERFORMANCE

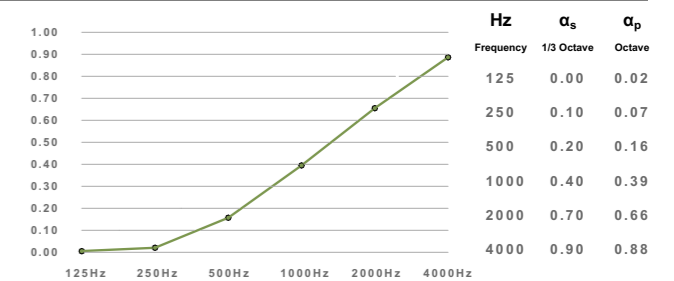

	$\alpha_w$	NRC	SAA	Class
Reference Product: Ridge	According to ISO 11654	According to ASTM C423	Sound Absorption Average	Sound Absorption
Hex-One	0.25	0.30	0.32	E

$\alpha_s$  Sound absorption coefficient according to ISO 354  $\alpha_p$  Practical sound absorption coefficient according to ISO 11654







Onyx

Visual Depth and Acoustics



# Onyx Form

Sound-Absorbing Decorative Panel

520mm x 600mm x 13mm

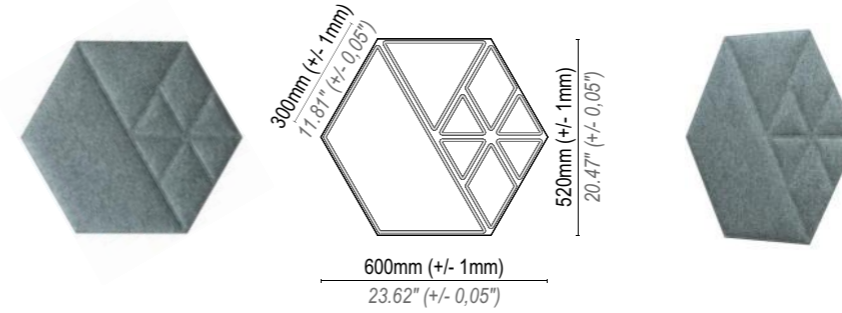

PRODUCT CODE / DESCRIPTION	Box Qty / m <sup>2</sup>	Inherent Colors			Color-IT Custom Colors								Peel & Stick (Optional)								
		Pearl White	Mist	Dark Grey	White	Lemon	Blue Green	Sky Blue	Violet	Pink	Light Green	Yellow	Orange	Red	Dark Red	Green	Blue	Black	Grey	White	
OXF-20AAN - Inherent Colors (Panel Only)	12 / 3.74 m <sup>2</sup>																				
OXF-20PSN - Inherent Colors + Peel & Stick	12 / 3.74 m <sup>2</sup>																				
OXF-20AAC - Color-IT (Panel Only)	12 / 3.74 m <sup>2</sup>																				
OXF-20PSC - Color-IT + Peel & Stick	12 / 3.74 m <sup>2</sup>																				

**APPLICATION**

Wall & Ceiling - Indoor use only

**MATERIAL**

Mechanical needled punch industrial felt.  
100% PET up to 60% Recycled content & Recyclable



Smooth Surface - Impact Resistance - Flexible

**FIRE RATING**

A Class (ASTM E84) - B s1 d0 (EN 13501-1)

**THERMAL INSULATION**

0,035 W/mK

**WEIGHT**

1 tile: 400 gr. +/- 10% tolerance  
1 tile: 0.88 lbs with +/- 10% tolerance

**THICKNESS**

Max. 13 mm (+/- 2 mm) - 0.51" (+/-0.08")  
Min. 3 mm (+/- 2 mm) - 0.12" (+/-0.08")

**BOX SIZE & CONTENT**

W: 620 mm D: 660 mm H: 190 mm  
W: 24.5" D: 26" H: 7.5"

1 Box: 12 x panels

1 Box: 3.744 m<sup>2</sup>

1 Box: 40.30 ft<sup>2</sup>

1 Color of choice per package

Gross weight: 6.0 kg

Gross weight: 13.22 lbs

**PALETTE SIZE & CONTENT**

W: 1220 mm D: 1015 mm H: 2150 mm  
W: 48" D: 40" H: 84.5"

30 Pcs. Box  
Gross Weight  
210 kg  
463 lbs

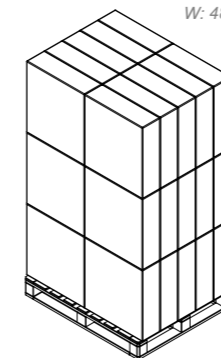

W: 1200 mm D: 800 mm H: 2150 mm  
W: 47.25" D: 31.5" H: 84.5"

24 Pcs. Box  
Gross Weight  
165 kg  
364 lbs

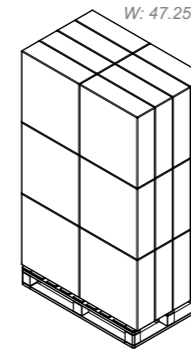

**ACOUSTIC PERFORMANCE**

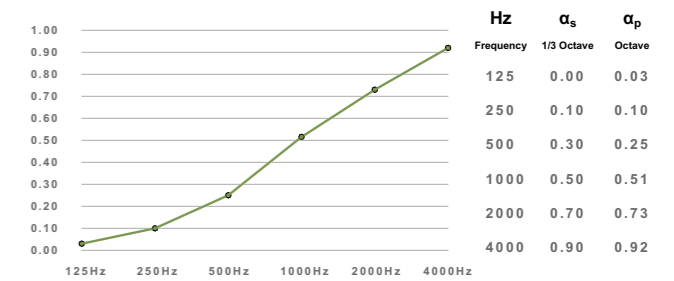

	α <sub>w</sub>	NRC	SAA	Class
	According to ISO 11654	According to ASTM C423	Sound Absorption Average	Sound Absorption
Onyx Form	0.30	0.40	0.40	D

α<sub>s</sub> Sound absorption coefficient according to ISO 354 α<sub>p</sub> Practical sound absorption coefficient according to ISO 11654





# Onyxa Trio

Sound-Absorbing Decorative Panel

520mm x 600mm x 13mm

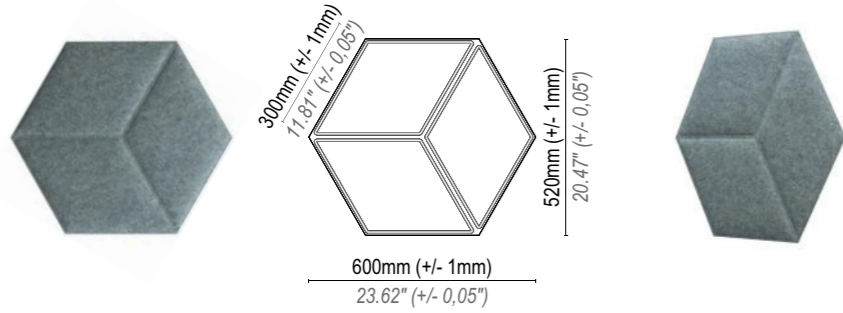

		Inherent Colors	Color-IT Custom Colors	Peel & Stick (Optional)
<b>PRODUCT CODE / DESCRIPTION</b>	<b>Box Qty / m<sup>2</sup></b>			
OXT-20AAN - Inherent Colors (Panel Only)	12 / 3.74 m <sup>2</sup>			
OXT-20PSN - Inherent Colors + Peel & Stick	12 / 3.74 m <sup>2</sup>			
OXT-20AAC - Color-IT (Panel Only)	12 / 3.74 m <sup>2</sup>			
OXT-20PSC - Color-IT + Peel & Stick	12 / 3.74 m <sup>2</sup>			

**APPLICATION**  
Wall & Ceiling - Indoor use only

**MATERIAL**  
Mechanical needled punch industrial felt.  
100% PET up to 60% Recycled content & Recyclable

Smooth Surface - Impact Resistance - Flexible

**FIRE RATING**  
A Class (ASTM E84) - B s1 d0 (EN 13501-1)

**THERMAL INSULATION**  
0,035 W/mK

**WEIGHT**  
1 tile: 400 gr. +/- 10% tolerance  
1 tile: 0.88 lbs with +/- 10% tolerance

**THICKNESS**  
  
Max. 13 mm (+/- 2 mm) - 0.51" (+/-0.08")  
Min. 3 mm (+/- 2 mm) - 0.12" (+/-0.08")

**BOX SIZE & CONTENT**  
W: 620 mm D: 660 mm H: 190 mm  
W: 24.5" D: 26" H: 7.5"

**1 Box: 12 x panels**  
1 Box: 3.744 m<sup>2</sup>  
1 Box: 40.30 ft<sup>2</sup>  
**1 Color of choice per package**  
Gross weight: 6.0 kg  
Gross weight: 13.22 lbs



**PALETTE SIZE & CONTENT**

W: 1220 mm D: 1015 mm H: 2150 mm  
W: 48" D: 40" H: 84.5"

**30 Pcs. Box**  
Gross Weight  
**210 kg**  
463 lbs

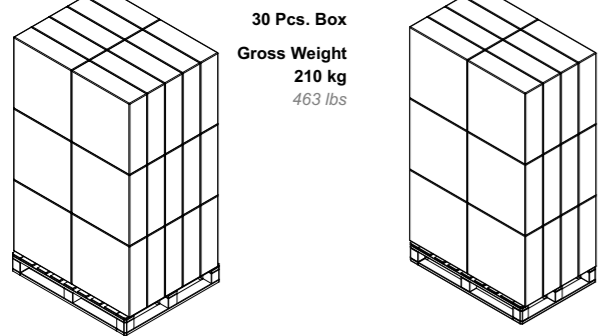

W: 1200 mm D: 800 mm H: 2150 mm  
W: 47.25" D: 31.5" H: 84.5"

**24 Pcs. Box**  
Gross Weight  
**165 kg**  
364 lbs

**ACOUSTIC PERFORMANCE**

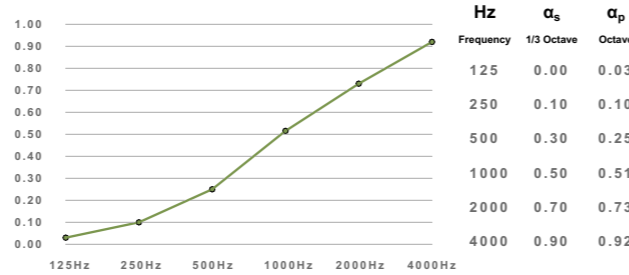

	α <sub>w</sub>	NRC	SAA	Class
According to ISO 11654 According to ASTM C423 Sound Absorption Average Sound Absorption				
Onyxa Trio	0.30	0.40	0.40	D

α<sub>s</sub> Sound absorption coefficient according to ISO 354 α<sub>p</sub> Practical sound absorption coefficient according to ISO 11654

# Onyxa Duo

Sound-Absorbing Decorative Panel

520mm x 600mm x 13mm

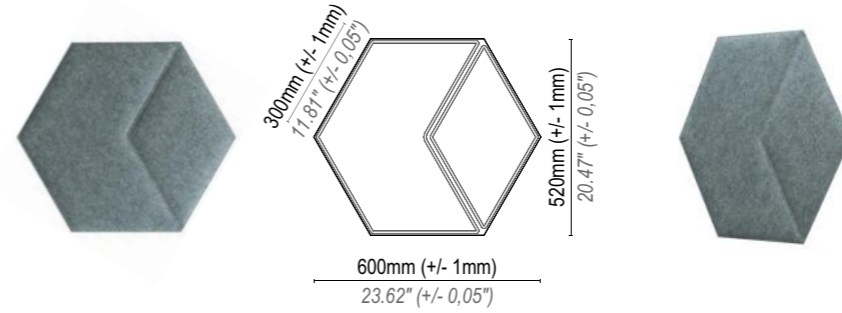

		Inherent Colors	Color-IT Custom Colors	Peel & Stick (Optional)
<b>PRODUCT CODE / DESCRIPTION</b>	<b>Box Qty / m<sup>2</sup></b>			
OXD-20AAN - Inherent Colors (Panel Only)	12 / 3.74 m <sup>2</sup>			
OXD-20PSN - Inherent Colors + Peel & Stick	12 / 3.74 m <sup>2</sup>			
OXD-20AAC - Color-IT (Panel Only)	12 / 3.74 m <sup>2</sup>			
OXD-20PSC - Color-IT + Peel & Stick	12 / 3.74 m <sup>2</sup>			

**APPLICATION**  
Wall & Ceiling - Indoor use only

**MATERIAL**  
Mechanical needled punch industrial felt.  
100% PET up to 60% Recycled content & Recyclable

Smooth Surface - Impact Resistance - Flexible

**FIRE RATING**  
A Class (ASTM E84) - B s1 d0 (EN 13501-1)

**THERMAL INSULATION**  
0,035 W/mK

**WEIGHT**  
1 tile: 400 gr. +/- 10% tolerance  
1 tile: 0.88 lbs with +/- 10% tolerance

**THICKNESS**  
  
Max. 13 mm (+/- 2 mm) - 0.51" (+/-0.08")  
Min. 3 mm (+/- 2 mm) - 0.12" (+/-0.08")

**BOX SIZE & CONTENT**  
W: 620 mm D: 660 mm H: 190 mm  
W: 24.5" D: 26" H: 7.5"

**1 Box: 12 x panels**  
1 Box: 3.744 m<sup>2</sup>  
1 Box: 40.30 ft<sup>2</sup>  
**1 Color of choice per package**  
Gross weight: 6.0 kg  
Gross weight: 13.22 lbs



**PALETTE SIZE & CONTENT**

W: 1220 mm D: 1015 mm H: 2150 mm  
W: 48" D: 40" H: 84.5"

**30 Pcs. Box**  
Gross Weight  
**210 kg**  
463 lbs

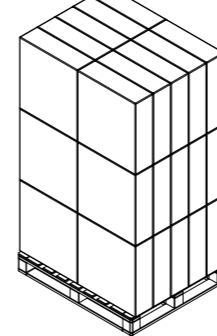

W: 1200 mm D: 800 mm H: 2150 mm  
W: 47.25" D: 31.5" H: 84.5"

**24 Pcs. Box**  
Gross Weight  
**165 kg**  
364 lbs

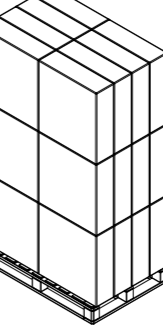

**ACOUSTIC PERFORMANCE**

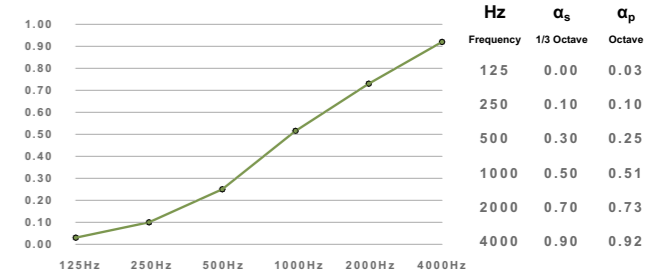

	α <sub>w</sub>	NRC	SAA	Class
According to ISO 11654 According to ASTM C423 Sound Absorption Average Sound Absorption				
Onyxa Duo	0.30	0.40	0.40	D

α<sub>s</sub> Sound absorption coefficient according to ISO 354 α<sub>p</sub> Practical sound absorption coefficient according to ISO 11654





## WoodyFelt

Transforming PET into Wood-Like Elegance

Our innovative 'Woody-Felt' uses eco-friendly printing on recycled PET felt to mimic wood without cutting trees.

This sustainable approach extends wood-like aesthetics to curved edges, achieving a seamless and environmentally responsible design.

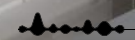





# WoodyFelt - Small

Sound-Absorbing Decorative Panel

150mm x 1200mm x 13mm



PRODUCT CODE / DESCRIPTION	Box Qty / m <sup>2</sup>	Color-IT Custom Colors		Peel & Stick (Optional)
		Light Oak	Dark Oak	
WFS-20AAC - Color-IT (Panel Only)	24 / 4.32 m <sup>2</sup>			
WFS-20PSC - Color-IT + Peel & Stick	24 / 4.32 m <sup>2</sup>			



**APPLICATION**  
Wall & Ceiling - Indoor use only

**MATERIAL**  
Mechanical needled punch industrial felt.  
100% PET up to 60% Recycled content & Recyclable



**FIRE RATING**  
A Class (ASTM E84) - B s1 d0 (EN 13501-1)

**THERMAL INSULATION**  
0,035 W/mK

**WEIGHT**  
1 tile: 250 gr. +/- 10% tolerance  
1 tile: 0.55 lbs with +/- 10% tolerance

**THICKNESS**

Max. 13 mm (+/- 2 mm) - 0.51" (+/-0.08")  
Min. 3 mm (+/- 2 mm) - 0.12" (+/-0.08")

**BOX SIZE & CONTENT**  
W: 620 mm D: 1220 mm H: 120 mm  
W: 24.5" D: 48" H: 4.73"

**1 Box: 24 x panels**  
1 Box: 4.32 m<sup>2</sup>  
1 Box: 46.50 ft<sup>2</sup>  
**1 Color of choice per package**  
Gross weight: 7.5 kg  
Gross weight: 16.5 lbs

**PALETTE SIZE & CONTENT**

W: 1220 mm D: 1015 mm H: 2150 mm  
W: 48" D: 40" H: 84.5"

**24 Pcs. Box**  
Gross Weight  
**180 kg**  
396 lbs

W: 1200 mm D: 800 mm H: 2150 mm  
W: 47.25" D: 31.5" H: 84.5"

**18 Pcs. Box**  
Gross Weight  
**135 kg**  
298 lbs



**ACOUSTIC PERFORMANCE**

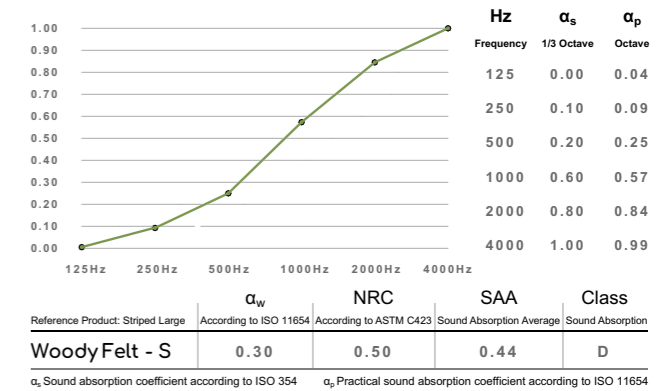





## Striped Large

Acoustic Art from Floor to Ceiling

With our large-sized panels, you can create floor-to-ceiling acoustic solutions using single-piece products.

Placing them side by side, vertically or horizontally, allows you to form symmetric or asymmetric patterns with their complementary designs.

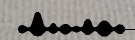





# Striped Large

Sound-Absorbing Decorative Panel

600mm x 2400mm x 13mm

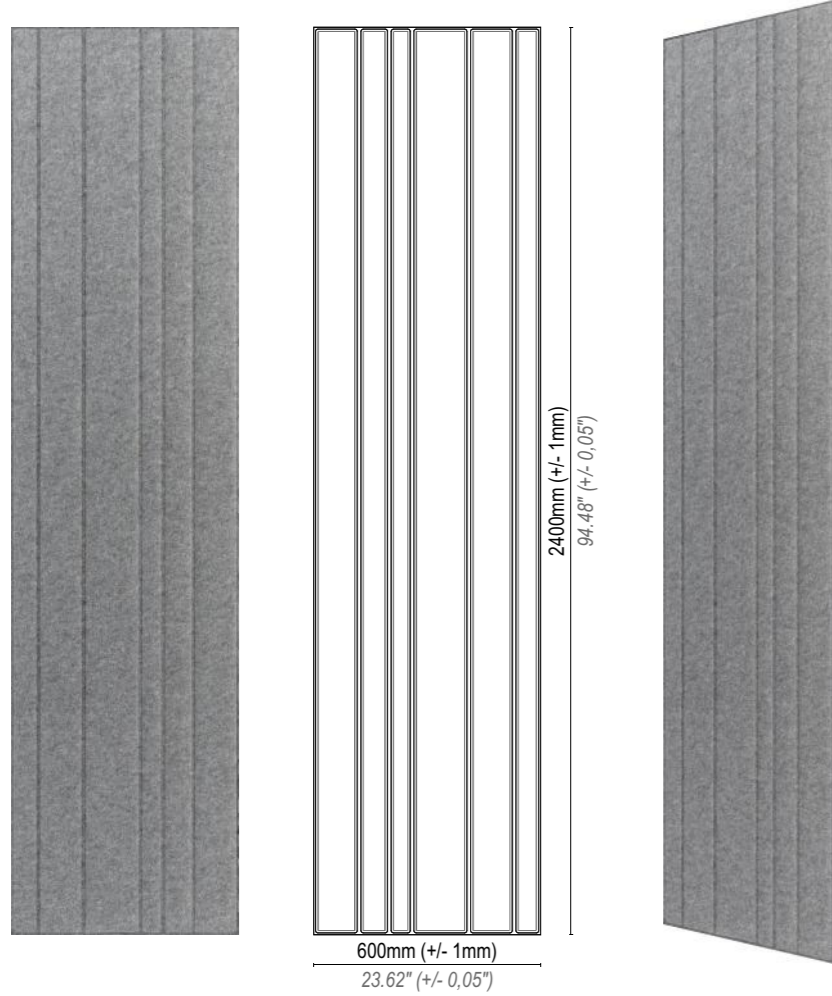

PRODUCT CODE / DESCRIPTION	Box Qty / m <sup>2</sup>
STL-20AAN - Inherent Colors (Panel Only)	6 / 8.64 m <sup>2</sup>
STL-20AAC - Color-IT (Panel Only)	6 / 8.64 m <sup>2</sup>

Inherent Colors	Color-IT Custom Colors	Peel & Stick (Optional)



**APPLICATION**  
Wall & Ceiling - Indoor use only

**MATERIAL**  
Mechanical needed punch industrial felt.  
100% PET up to 60% Recycled content & Recyclable

Smooth Surface - Impact Resistance - Flexible

**FIRE RATING**  
A Class (ASTM E84) - B s1 d0 (EN 13501-1)

**THERMAL INSULATION**  
0,035 W/mK

**WEIGHT**  
1 tile: 2000 gr. +/- 10% tolerance  
1 tile: 4.40 lbs with +/- 10% tolerance

**THICKNESS**  
Max. 13 mm (+/- 2 mm) - 0.51" (+/-0.08")  
Min. 3 mm (+/- 2 mm) - 0.12" (+/-0.08")

**BOX SIZE & CONTENT**  
W: 620 mm D: 2420 mm H: 120 mm  
W: 24.5" D: 65.3" H: 4.73"

**1 Box: 6 x panels**  
1 Box: 8.64 m<sup>2</sup>  
1 Box: 93 ft<sup>2</sup>

**1 Color of choice per package**  
Gross weight: 14.5 kg  
Gross weight: 32 lbs



**PALETTE SIZE & CONTENT**

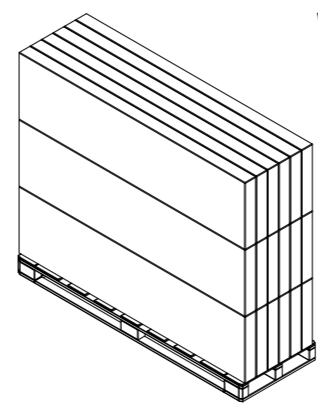

W: 1200 mm D: 800 mm H: 2150 mm  
W: 47.25" D: 31.5" H: 84.5"

**18 Pcs. Box**

**Gross Weight**  
261 kg  
575 lbs

**ACOUSTIC PERFORMANCE**

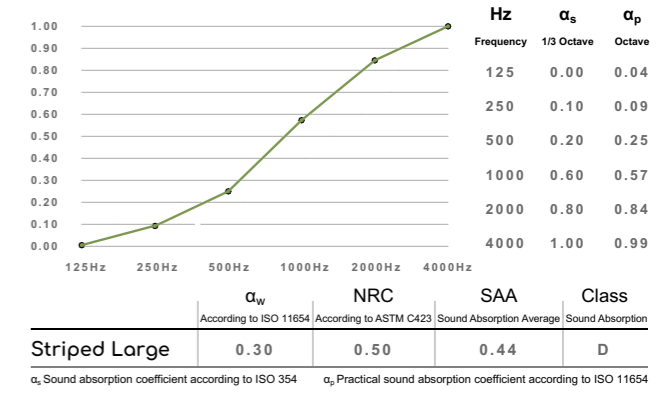





Drop-In Tiles







# Drop-In Tiles

Our Drop-In tiles seamlessly integrate into your existing Lay-In T24 or T15 suspended ceiling grid systems.

With no need for specialized installation, these tiles offer a simple way to introduce design innovation to your familiar space while addressing reverberation issues.

Alternatively, you can start your projects from scratch using this universally compatible suspended ceiling carrier system, which is both easy to use and cost-effective.



# Drop-In Tiles

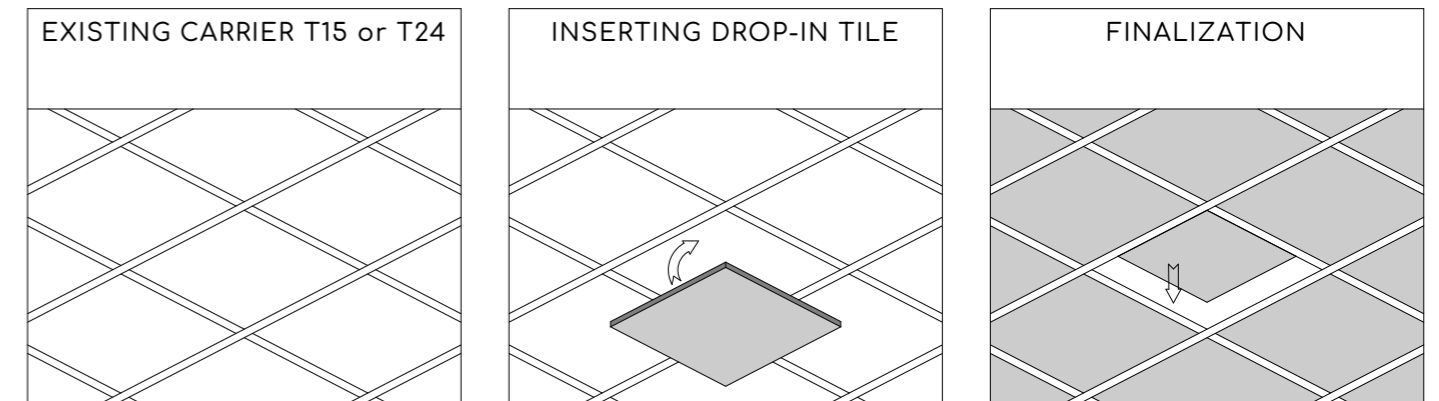
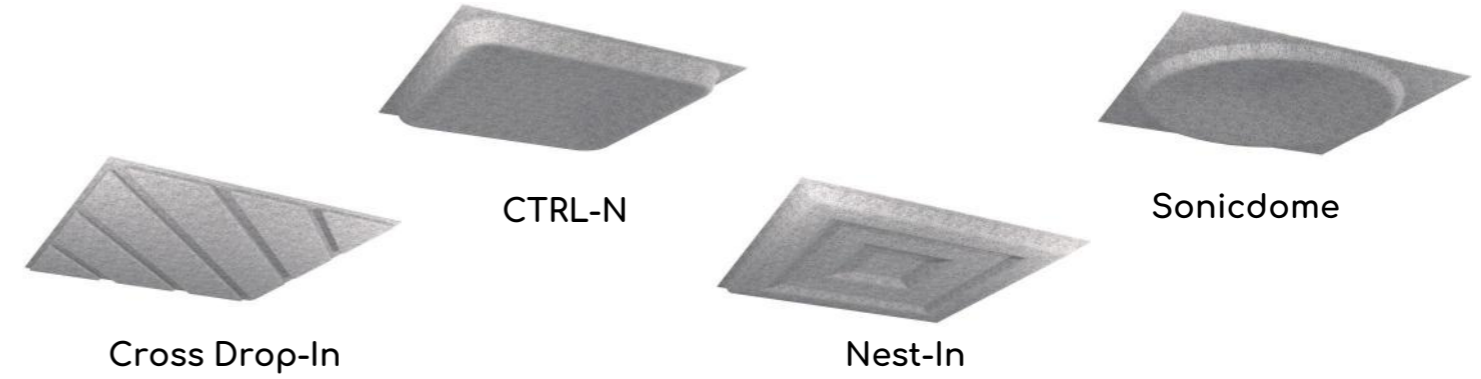





# Cross Drop-In

Sound-Absorbing Decorative Ceiling & Wall Panel

595mm x 595mm x 40mm

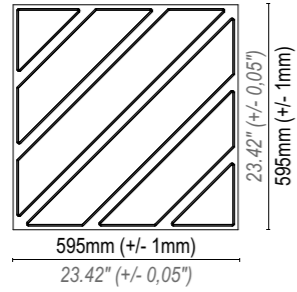

**THICKNESS**  
T: 20mm (+/- 1mm) 0.78" (+/- 0,05")

PRODUCT CODE / DESCRIPTION	Box Qty / m <sup>2</sup>	Inherent Colors	Color-IT Custom Colors
		CRS-20DRN - Inherent Colors (Panel Only)	12 / 4.248 m <sup>2</sup>
CRS-20DRC - Color-IT (Panel Only)	12 / 4.248 m <sup>2</sup>		

**APPLICATION**  
3D molded ceiling panel  
Suitable for "T15" & "T24",  
suspended ceiling carrier systems  
Only panels are included

**MATERIAL**  
Mechanical needled punch industrial felt.  
100% PET up to 60% Recycled content & Recyclable

**FIRE RATING**  
A Class (ASTM E84) - B s1 d0 (EN 13501-1)

**THERMAL INSULATION**  
0,035 W/mK

**WEIGHT**  
1 tile: 600 gr. +/- 10% tolerance  
1 tile: 1.32 lbs with +/- 10% tolerance

**BOX SIZE & CONTENT**  
W: 620 mm D: 660 mm H: 190 mm  
W: 24.5" D: 26" H: 7.5"  
1 Box: 12 x panels  
1 Box: 4.248 m<sup>2</sup>  
1 Box: 45.725 ft<sup>2</sup>  
1 Color of choice per package  
Gross weight: 8.3 kg  
Gross weight: 18.3 lbs



## PALETTE SIZE & CONTENT

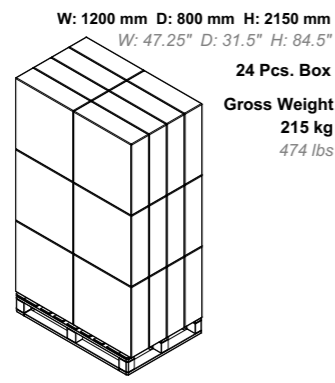
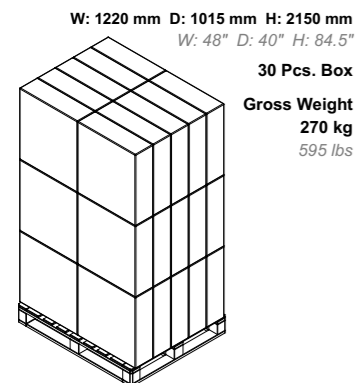

## ACOUSTIC PERFORMANCE

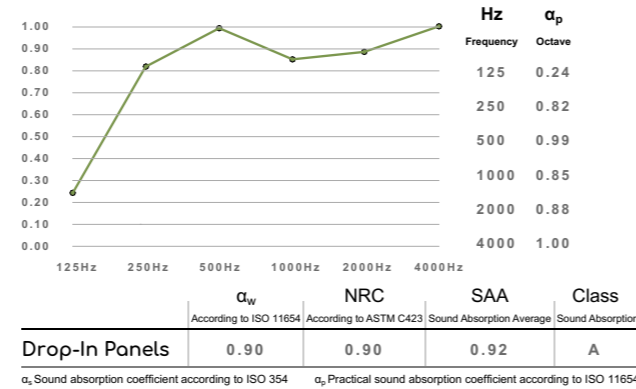

# CTRL-N

Sound-Absorbing Decorative Panel

595mm x 595mm x 40mm

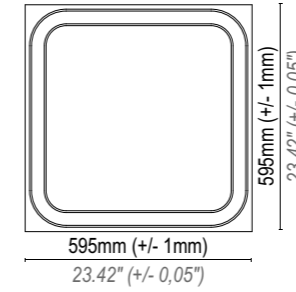

**THICKNESS**  
T: 40mm (+/- 1mm) 1.57" (+/- 0,05")

PRODUCT CODE / DESCRIPTION	Box Qty / m <sup>2</sup>	Inherent Colors	Color-IT Custom Colors
		CRL-20DRN - Inherent Colors (Panel Only)	12 / 4.248 m <sup>2</sup>
CRL-20DRC - Color-IT (Panel Only)	12 / 4.248 m <sup>2</sup>		

**APPLICATION**  
3D molded ceiling panel  
Suitable for "T15" & "T24",  
suspended ceiling carrier systems  
Only panels are included

**MATERIAL**  
Mechanical needled punch industrial felt.  
100% PET up to 60% Recycled content & Recyclable

**FIRE RATING**  
A Class (ASTM E84) - B s1 d0 (EN 13501-1)

**THERMAL INSULATION**  
0,035 W/mK

**WEIGHT**  
1 tile: 600 gr. +/- 10% tolerance  
1 tile: 1.32 lbs with +/- 10% tolerance

**BOX SIZE & CONTENT**  
W: 620 mm D: 660 mm H: 190 mm  
W: 24.5" D: 26" H: 7.5"  
1 Box: 12 x panels  
1 Box: 4.248 m<sup>2</sup>  
1 Box: 45.725 ft<sup>2</sup>  
1 Color of choice per package  
Gross weight: 8.3 kg  
Gross weight: 18.3 lbs

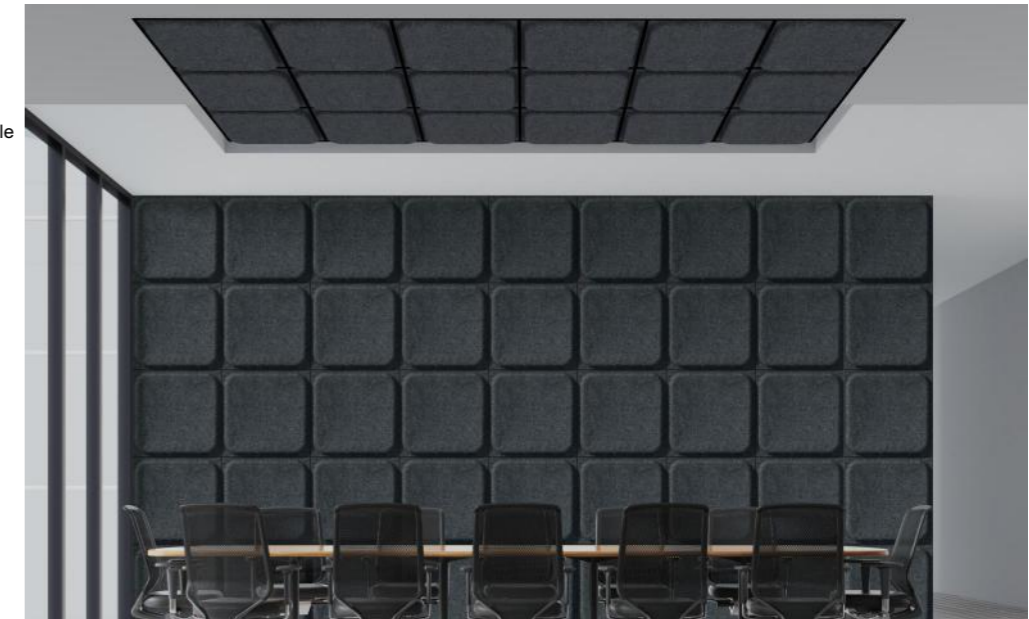

## PALETTE SIZE & CONTENT

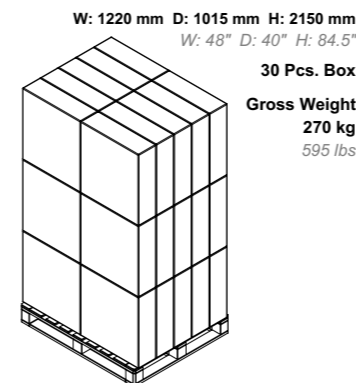

## ACOUSTIC PERFORMANCE

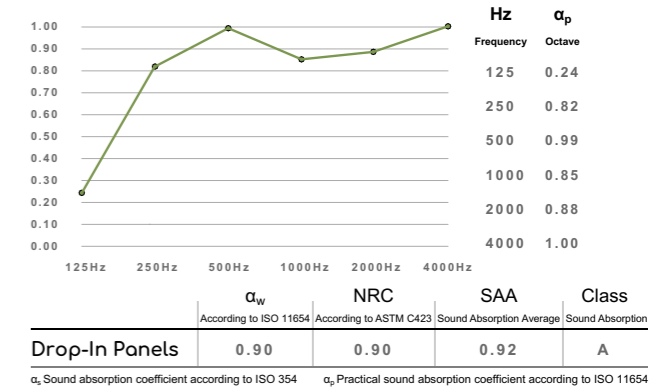





# Nest-In

Sound-Absorbing Decorative Ceiling Panel

595mm x 595mm x 40mm

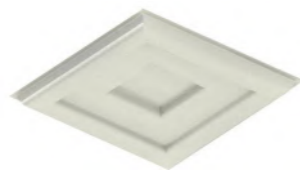
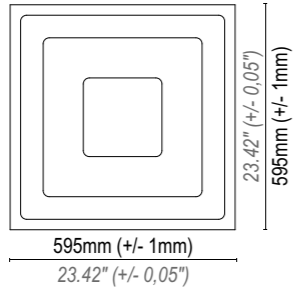

**THICKNESS**  
T: 40mm (+/- 1mm) 1.57" (+/- 0,05")

PRODUCT CODE / DESCRIPTION	Box Qty / m <sup>2</sup>	Inherent Colors	Color-IT Custom Colors
		NST-20DRN - Inherent Colors (Panel Only)	12 / 4.248 m <sup>2</sup>
NST-20DRC - Color-IT (Panel Only)	12 / 4.248 m <sup>2</sup>		

**APPLICATION**  
3D molded ceiling panel  
Suitable for "T15" & "T24",  
suspended ceiling carrier systems  
Only panels are included

**MATERIAL**  
Mechanical needled punch industrial felt.  
100% PET up to 60% Recycled content & Recyclable

**FIRE RATING**  
A Class (ASTM E84) - B s1 d0 (EN 13501-1)

**THERMAL INSULATION**  
0,035 W/mK

**WEIGHT**  
1 tile: 600 gr. +/- 10% tolerance  
1 tile: 1.32 lbs with +/- 10% tolerance

**BOX SIZE & CONTENT**  
W: 620 mm D: 660 mm H: 190 mm  
W: 24.5" D: 26" H: 7.5"  
1 Box: 12 x panels  
1 Box: 4.248 m<sup>2</sup>  
1 Box: 45.725 ft<sup>2</sup>  
1 Color of choice per package  
Gross weight: 8.3 kg  
Gross weight: 18.3 lbs



## PALETTE SIZE & CONTENT

W: 1220 mm D: 1015 mm H: 2150 mm  
W: 48" D: 40" H: 84.5"  
30 Pcs. Box  
Gross Weight  
270 kg  
595 lbs

W: 1200 mm D: 800 mm H: 2150 mm  
W: 47.25" D: 31.5" H: 84.5"  
24 Pcs. Box  
Gross Weight  
215 kg  
474 lbs

## ACOUSTIC PERFORMANCE

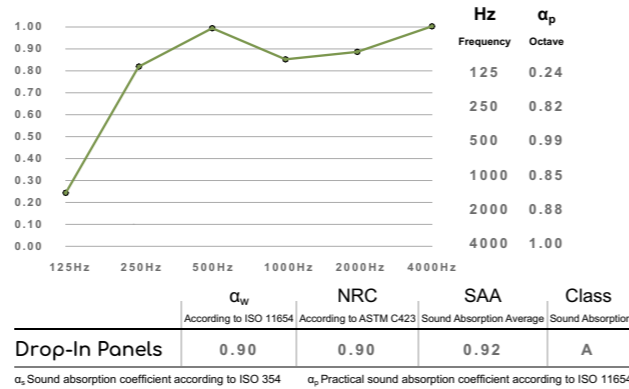

# Sonicdome

Sound-Absorbing Decorative Panel

595mm x 595mm x 40mm

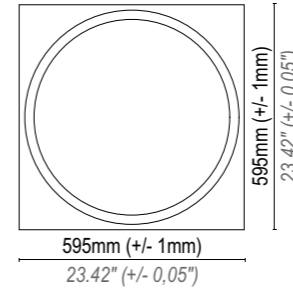

**THICKNESS**  
T: 40mm (+/- 1mm) 1.57" (+/- 0,05")

PRODUCT CODE / DESCRIPTION	Box Qty / m <sup>2</sup>	Inherent Colors	Color-IT Custom Colors
		CRL-20DRN - Inherent Colors (Panel Only)	12 / 4.248 m <sup>2</sup>
CRL-20DRC - Color-IT (Panel Only)	12 / 4.248 m <sup>2</sup>		

**APPLICATION**  
3D molded ceiling panel  
Suitable for "T15" & "T24",  
suspended ceiling carrier systems  
Only panels are included

**MATERIAL**  
Mechanical needled punch industrial felt.  
100% PET up to 60% Recycled content & Recyclable

**FIRE RATING**  
A Class (ASTM E84) - B s1 d0 (EN 13501-1)

**THERMAL INSULATION**  
0,035 W/mK

**WEIGHT**  
1 tile: 600 gr. +/- 10% tolerance  
1 tile: 1.32 lbs with +/- 10% tolerance

**BOX SIZE & CONTENT**  
W: 620 mm D: 660 mm H: 190 mm  
W: 24.5" D: 26" H: 7.5"  
1 Box: 12 x panels  
1 Box: 4.248 m<sup>2</sup>  
1 Box: 45.725 ft<sup>2</sup>  
1 Color of choice per package  
Gross weight: 8.3 kg  
Gross weight: 18.3 lbs



## PALETTE SIZE & CONTENT

W: 1220 mm D: 1015 mm H: 2150 mm  
W: 48" D: 40" H: 84.5"  
30 Pcs. Box  
Gross Weight  
270 kg  
595 lbs

W: 1200 mm D: 800 mm H: 2150 mm  
W: 47.25" D: 31.5" H: 84.5"  
24 Pcs. Box  
Gross Weight  
215 kg  
474 lbs

## ACOUSTIC PERFORMANCE

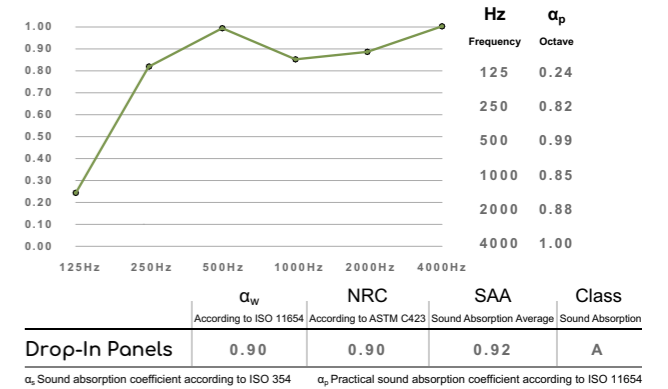





Sound Blades

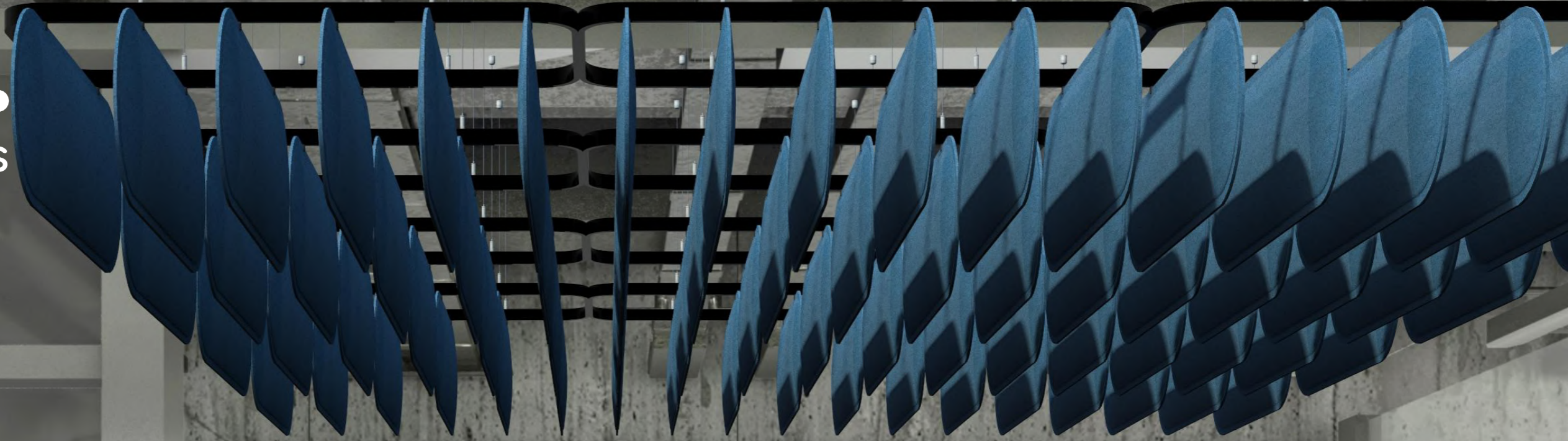

**ACOUST-IT**  
Acoustics in Style & Eco-Care





# Blade Small

## Cutting Through Noise

'Blade' sound baffles are designed to provide superior acoustic management by effectively reducing noise and reverberation in large, open spaces.

Suspended vertically from the ceiling, these baffles are perfect for use in areas such as offices, auditoriums, and conference rooms.

With easy installation and customizable options, Blade sound baffles offer a practical and stylish solution for creating quieter, more comfortable spaces.



# Blade Small

300mm x 900mm x 20mm

### APPLICATION

Wall with hook & loop 4x per unit

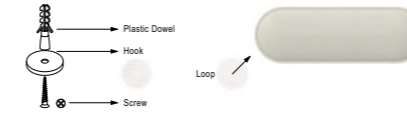

Ceiling with hanging wires 2x per unit

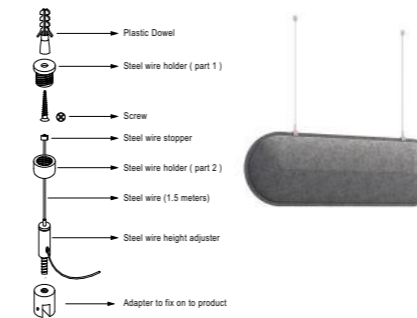

Module with metal carrier & hanging wires



### MATERIAL

Mechanical needled punch industrial felt.  
100% PET up to 60% Recycled content & Recyclable  
Smooth Surface - Impact Resistance - Flexible

### FIRE RATING

A Class (ASTM E84) - B s1 d0 (EN 13501-1)

### THERMAL INSULATION

0,035 W/mK

### WEIGHT

1 tile: 565 gr. +/- 10% tolerance  
1 tile: 1.24 lbs with +/- 10% tolerance

### THICKNESS



Max. 20mm (+/- 2mm) - 0.78" (+/- 0.08")  
Min. 5mm (+/- 2mm) - 0.19" (+/- 0.08")

### BOX SIZE & CONTENT

W: 920 mm D: 920 mm H: 120 mm  
W: 36.22" D: 36.22" H: 4.72"

1 Box: 12 x panels

1 Box: 3.012 m<sup>2</sup>

1 Box: 34.421 ft<sup>2</sup>

1 Color of choice per package

Gross weight: 8.0 kg

Gross weight: 17.63 lbs

### PALETTE SIZE & CONTENT

W: 1220 mm D: 1015 mm H: 2150 mm  
W: 48" D: 40" H: 84.5"

20 Pcs. Box  
Gross Weight  
180 kg  
396 lbs

12 Pcs. Box  
Gross Weight  
115 kg  
254 lbs

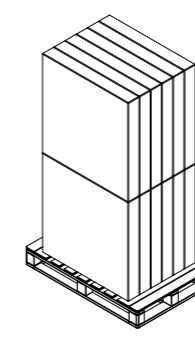
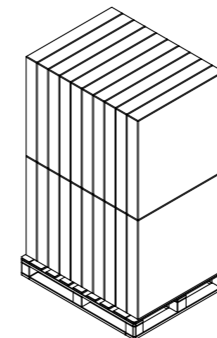

### ACOUSTIC PERFORMANCE

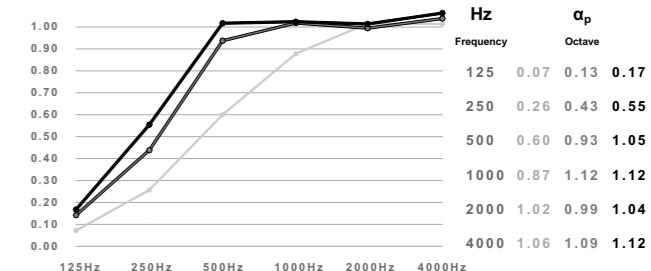

	alpha_w	NRC	SAA	Class
Blade Small	0.55	0.70	0.69	D
On the surface	0.70	0.90	0.88	C
Distance to surface: 50mm	0.85	1.00	0.94	B

alpha\_w Sound absorption coefficient according to ISO 354 alpha\_p Practical sound absorption coefficient according to ISO 11654





# Blade Small

Sound-Absorbing Decorative Ceiling Pendant & Wall Panel

300mm x 900mm x 20mm

## WALL



Detachable  
Hook & Loop  
Patches

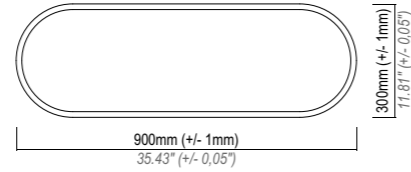

PRODUCT CODE / DESCRIPTION	Box Qty / m <sup>2</sup>	Inherent Colors	Color-IT Custom Colors	Hook & Loop (Optional)
BSW-30AAN - Inherent Colors (Panel Only)	12 / 3.01 m <sup>2</sup>			
BSW-30VCN - Inherent Colors + Hook & Loop	12 / 3.01 m <sup>2</sup>			
BSW-30AAC - Color-IT (Panel Only)	12 / 3.01 m <sup>2</sup>			
BSW-30VCC - Color-IT + Hook & Loop	12 / 3.01 m <sup>2</sup>			

## CEILING

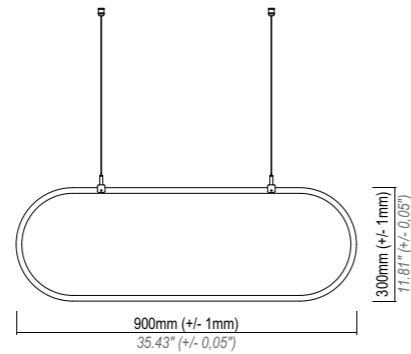

PRODUCT CODE / DESCRIPTION	Box Qty / m <sup>2</sup>	Inherent Colors	Color-IT Custom Colors	Hanging Set
BSH-20HSN - Inherent Colors + Hanging Set	12 / 3.01 m <sup>2</sup>			
BSH-20HSC - Color-IT + Hanging Set	12 / 3.01 m <sup>2</sup>			

## CEILING MODULE

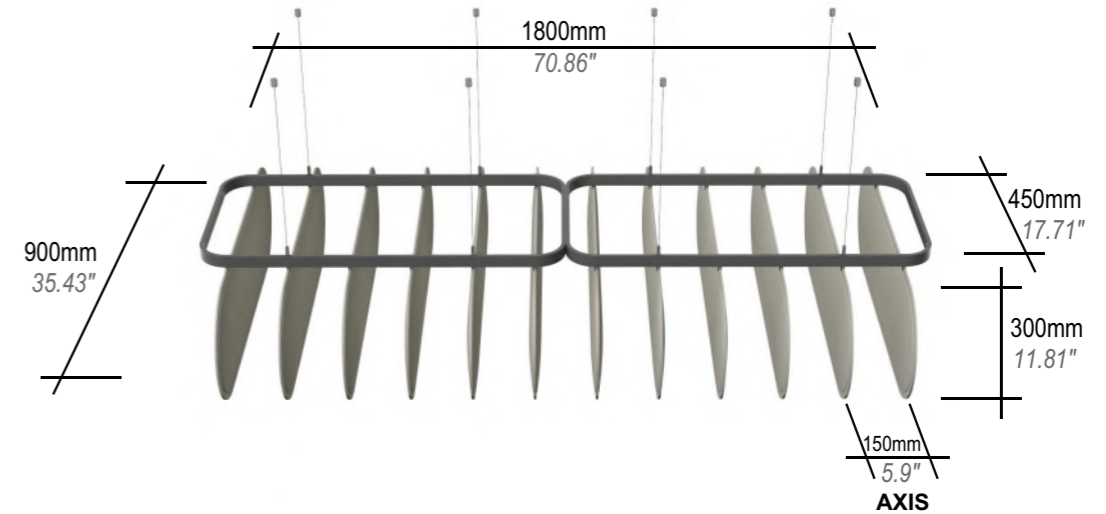
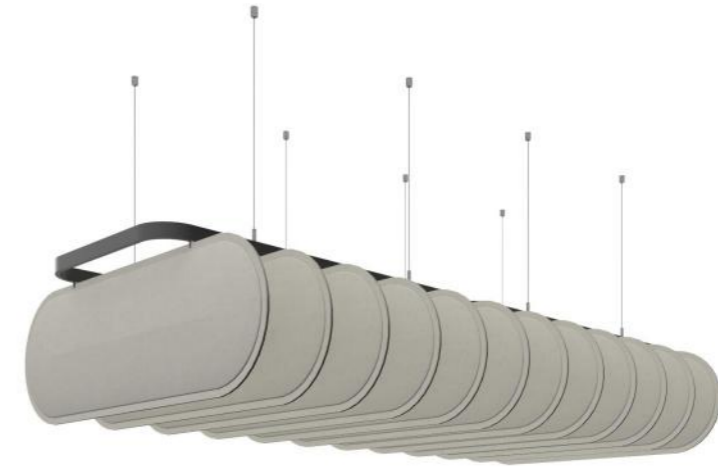

PRODUCT CODE / DESCRIPTION	Box Qty / m <sup>2</sup>	Inherent Colors	Color-IT Custom Colors	Carrier System & Hangers
BSM-20HSN - Inherent Colors + Hanging Set	12 / 3.01 m <sup>2</sup>			
BSM-20HSC - Color-IT + Hanging Set	12 / 3.01 m <sup>2</sup>			





# Blade Medium

## Cutting Through Noise

'Blade' sound baffles are designed to provide superior acoustic management by effectively reducing noise and reverberation in large, open spaces.

Suspended vertically from the ceiling, these baffles are perfect for use in areas such as offices, auditoriums, and conference rooms.

With easy installation and customizable options, Blade sound baffles offer a practical and stylish solution for creating quieter, more comfortable spaces.



# Blade Medium

1200mm x 300mm x 20mm

### APPLICATION

Wall with hook & loop 4x per unit

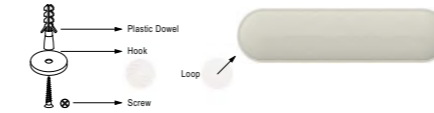

Ceiling with hanging wires 2x per unit

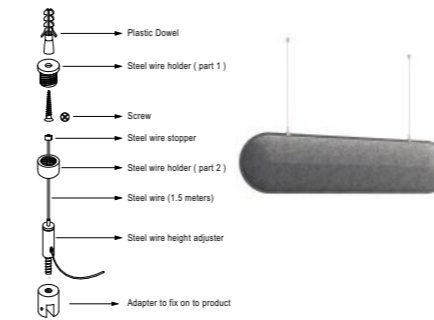

Module with metal carrier & hanging wires

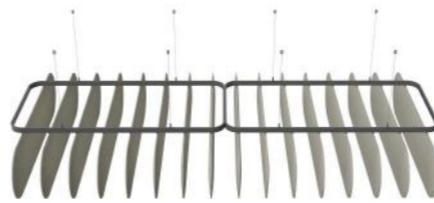

### MATERIAL

Mechanical needled punch industrial felt.  
100% PET up to 60% Recycled content & Recyclable  
Smooth Surface - Impact Resistance - Flexible

### FIRE RATING

A Class (ASTM E84) - B s1 d0 (EN 13501-1)

### THERMAL INSULATION

0,035 W/mK

### WEIGHT

1 tile: 765 gr. +/- 10% tolerance  
1 tile: 1.68 lbs with +/- 10% tolerance

### THICKNESS



Max. 20mm (+/- 2mm) - 0.78" (+/-0.08")  
Min. 5mm (+/- 2mm) - 0.19" (+/-0.08")

### BOX SIZE & CONTENT

W: 1220 mm D: 1220 mm H: 120 mm  
W: 48.03" D: 48.03" H: 4.72"

1 Box: 16 x panels

1 Box: 5.45 m<sup>2</sup>

1 Box: 58.66 ft<sup>2</sup>

1 Color of choice per package

Gross weight: 15 kg

Gross weight: 33.07 lbs

### PALETTE SIZE & CONTENT

W: 1220 mm D: 1015 mm H: 1400 mm  
W: 48" D: 40" H: 55"

8 Pcs. Box

Gross Weight  
140 kg  
308 lbs

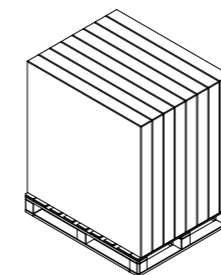

W: 1200 mm D: 800 mm H: 1400 mm  
W: 47.25" D: 31.5" H: 55"

7 Pcs. Box

Gross Weight  
120 kg  
264 lbs

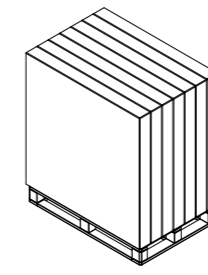

### ACOUSTIC PERFORMANCE

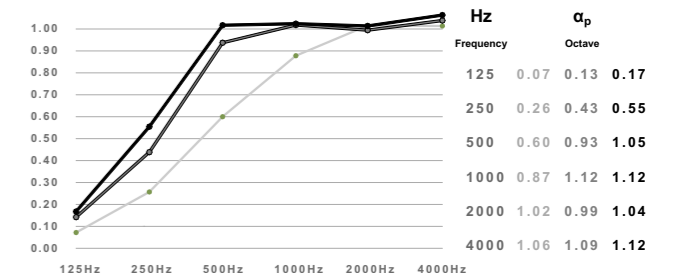

	$\alpha_w$	NRC	SAA	Class
Blade Medium	0.55	0.70	0.69	D
On the surface	0.55	0.70	0.69	D
Distance to surface: 50mm	0.70	0.90	0.88	C
Distance to surface: 100mm	0.85	1.00	0.94	B

$\alpha_w$  Sound absorption coefficient according to ISO 354  $\alpha_p$  Practical sound absorption coefficient according to ISO 11654





# Blade Medium

Sound-Absorbing Decorative Ceiling Pendant & Wall Panel

300mm x 1200mm x 20mm

## WALL



Detachable Hook & Loop Patches

PRODUCT CODE / DESCRIPTION	Box Qty / m <sup>2</sup>	Inherent Colors	Color-IT Custom Colors	Hook & Loop (Optional)
		BMW-30AAN - Inherent Colors (Panel Only)	16 / 5.45 m <sup>2</sup>	
BMW-30VCN - Inherent Colors + Hook & Loop	16 / 5.45 m <sup>2</sup>			
BMW-30AAC - Color-IT (Panel Only)	16 / 5.45 m <sup>2</sup>			
BMW-30VCC - Color-IT + Hook & Loop	16 / 5.45 m <sup>2</sup>			

## CEILING

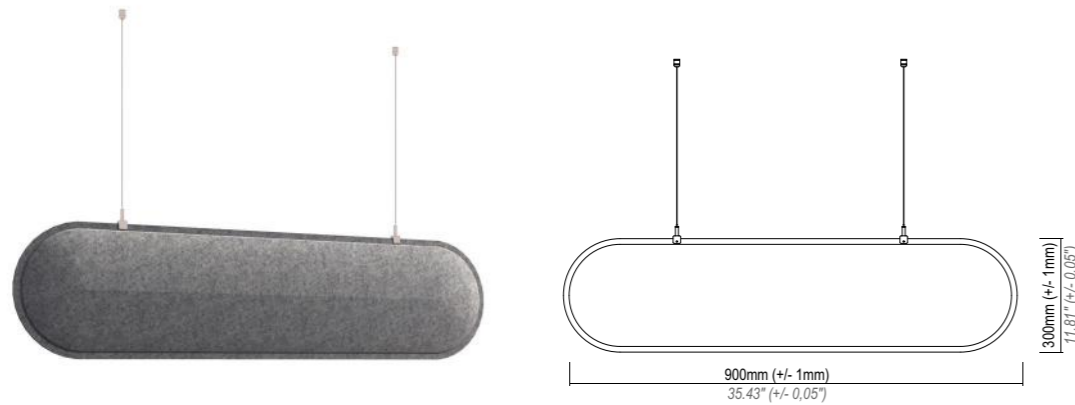

PRODUCT CODE / DESCRIPTION	Box Qty / m <sup>2</sup>	Inherent Colors	Color-IT Custom Colors	Hanging Set
		BSH-20HSN - Inherent Colors + Hanging Set	16 / 5.45 m <sup>2</sup>	
BSH-20HSC - Color-IT + Hanging Set	16 / 5.45 m <sup>2</sup>			

## CEILING MODULE

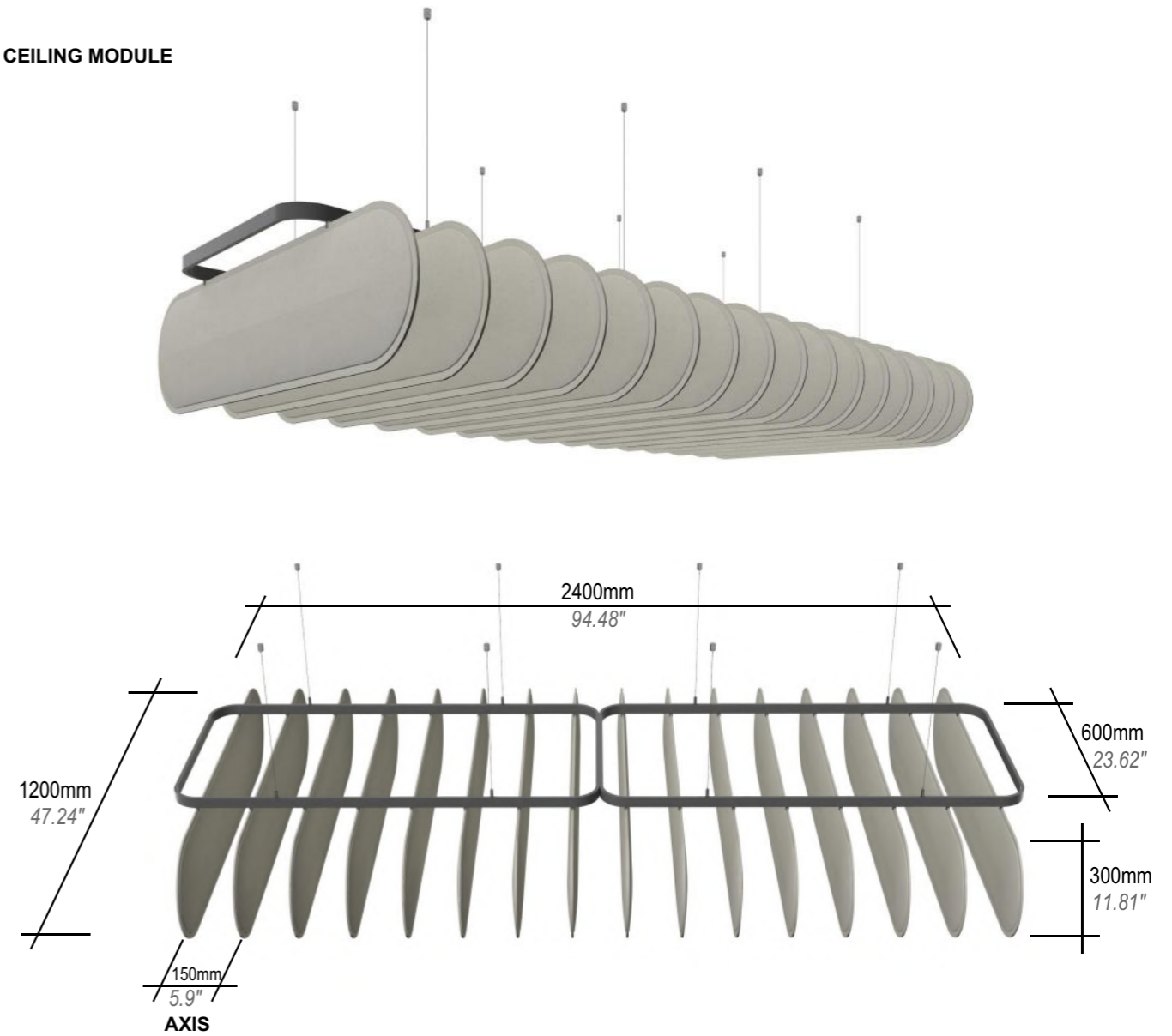

PRODUCT CODE / DESCRIPTION	Box Qty / m <sup>2</sup>	Inherent Colors	Color-IT Custom Colors	Carrier System & Hangers
		BSM-20HSN - Inherent Colors + Hanging Set	16 / 5.45 m <sup>2</sup>	
BSM-20HSC - Color-IT + Hanging Set	16 / 5.45 m <sup>2</sup>			





# Blade Large

## Cutting Through Noise

'Blade' sound baffles are designed to provide superior acoustic management by effectively reducing noise and reverberation in large, open spaces.

Suspended vertically from the ceiling, these baffles are perfect for use in areas such as offices, auditoriums, and conference rooms.

With easy installation and customizable options, Blade sound baffles offer a practical and stylish solution for creating quieter, more comfortable spaces.



# Blade Large

Sound-Absorbing Decorative Ceiling Pendant & Wall Panel

1200mm x 400mm x 20mm

Price List / € - 2024



### APPLICATION

Wall with hook & loop 4x per unit



Ceiling with hanging wires 2x per unit

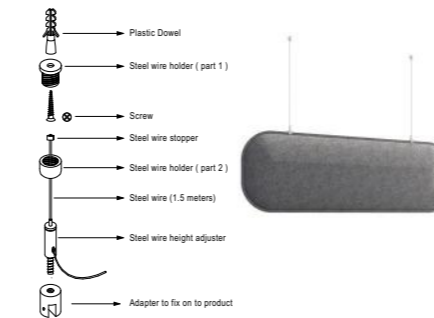

Module with metal carrier & hanging wires



### MATERIAL

Mechanical needed punch industrial felt.  
100% PET up to 60% Recycled content & Recyclable  
Smooth Surface - Impact Resistance - Flexible

### FIRE RATING

A Class (ASTM E84) - B s1 d0 (EN 13501-1)

### THERMAL INSULATION

0,035 W/mK

### WEIGHT

1 tile: 1050 gr. +/- 10% tolerance

1 tile: 2.31 lbs with +/- 10% tolerance

### THICKNESS



Max. 20mm (+/- 2mm) - 0.78" (+/-0.08")

Min. 5mm (+/- 2mm) - 0.19" (+/-0.08")

### BOX SIZE & CONTENT

W: 1220 mm D: 1220 mm H: 120 mm

W: 48.03" D: 48.03" H: 4.72"

1 Box: 12 x panels

1 Box: 5.53 m<sup>2</sup>

1 Box: 59.52 ft<sup>2</sup>

1 Color of choice per package

Gross weight: 15 kg

Gross weight: 33.07 lbs

### PALETTE SIZE & CONTENT

W: 1220 mm D: 1015 mm H: 1400 mm  
W: 48" D: 40" H: 55"

8 Pcs. Box

Gross Weight

140 kg

308 lbs

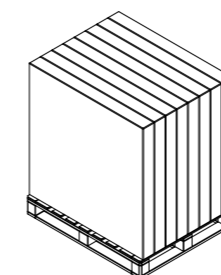

W: 1200 mm D: 800 mm H: 1400 mm  
W: 47.25" D: 31.5" H: 55"

7 Pcs. Box

Gross Weight

120 kg

264 lbs

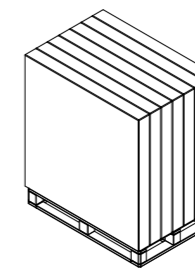

### ACOUSTIC PERFORMANCE

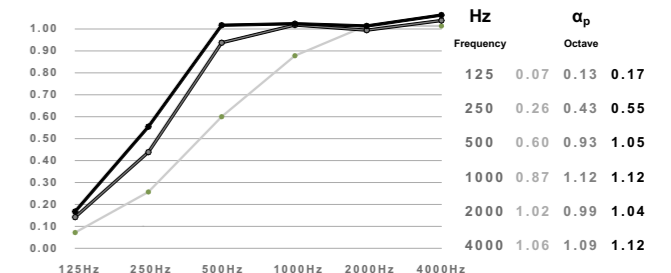

	$\alpha_w$	NRC	SAA	Class
	According to ISO 11654	According to ASTM C423	Sound Absorption Average	Sound Absorption
On the surface	0.55	0.70	0.69	D
Distance to surface: 50mm	0.70	0.90	0.88	C
Distance to surface: 100mm	<b>0.85</b>	<b>1.00</b>	<b>0.94</b>	<b>B</b>

$\alpha_w$  Sound absorption coefficient according to ISO 354  $\alpha_p$  Practical sound absorption coefficient according to ISO 11654

www.acoustit.com







# Blade Large

Sound-Absorbing Decorative Ceiling Pendant & Wall Panel

400mm x 1200mm x 20mm

## WALL



Detachable Hook & Loop Patches

PRODUCT CODE / DESCRIPTION	Box Qty / m <sup>2</sup>	Inherent Colors	Color-IT Custom Colors	Hook & Loop (Optional)
		BLW-30AAN - Inherent Colors (Panel Only)	12 / 5.53 m <sup>2</sup>	
BLW-30VCN - Inherent Colors + Hook & Loop	12 / 5.53 m <sup>2</sup>			
BLW-30AAC - Color-IT (Panel Only)	12 / 5.53 m <sup>2</sup>			
BLW-30VCC - Color-IT + Hook & Loop	12 / 5.53 m <sup>2</sup>			

## CEILING

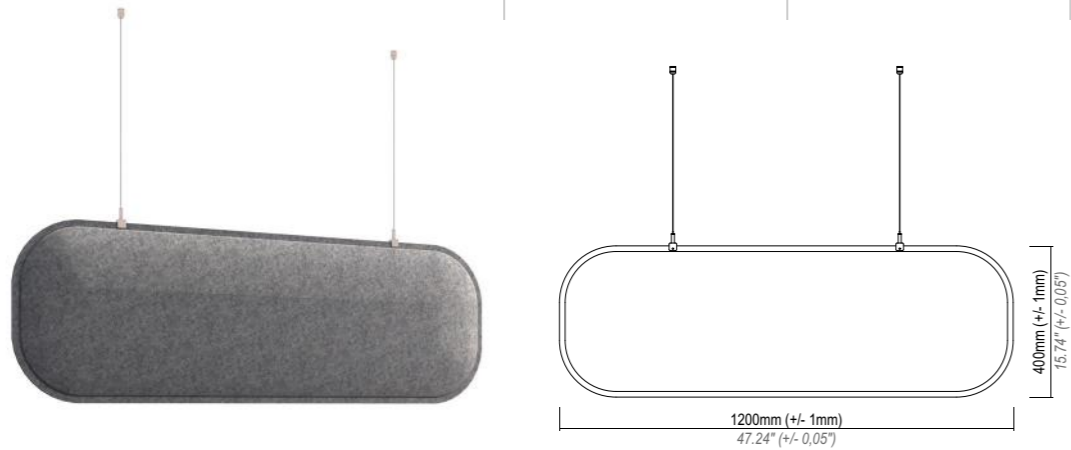

PRODUCT CODE / DESCRIPTION	Box Qty / m <sup>2</sup>	Inherent Colors	Color-IT Custom Colors	Hanging Set
		BSH-20HSN - Inherent Colors + Hanging Set	12 / 5.53 m <sup>2</sup>	
BSH-20HSC - Color-IT + Hanging Set	12 / 5.53 m <sup>2</sup>			

## CEILING MODULE

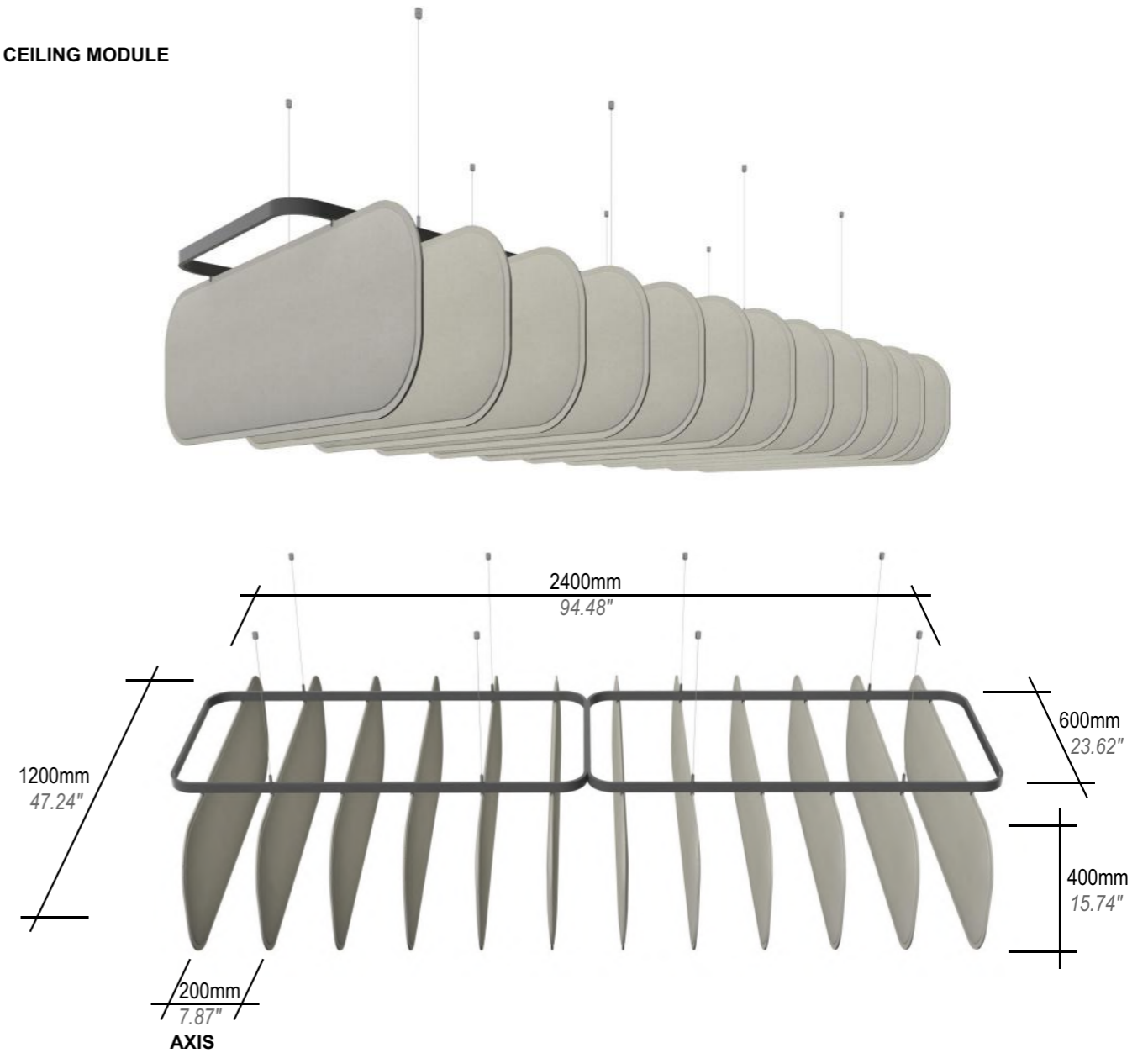

PRODUCT CODE / DESCRIPTION	Box Qty / m <sup>2</sup>	Inherent Colors	Color-IT Custom Colors	Carrier System & Hangers
		BSM-20HSN - Inherent Colors + Hanging Set	12 / 5.53 m <sup>2</sup>	
BSM-20HSC - Color-IT + Hanging Set	12 / 5.53 m <sup>2</sup>			











## Sound Clouds

Rotund Small, Medium & Large - Coleo Large

Up Silence in the Clouds

'Rotund' Sound Clouds deliver Class-A acoustic performance for superior noise reduction.

These versatile "clouds" are ideal for both ceiling and wall applications, enhancing sound quality while adding modern aesthetic appeal.

'Rotund' Sound Clouds are ideal to create focal points, add visual interest, and provide targeted acoustic treatment.

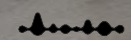

























## Sound Clouds

Oblong Small, Frame Large & Oblong Large

Linear Clouds for Large Spaces

'Oblong' and 'Frame' rectangular sound clouds are perfect for efficiently covering large ceiling and wall spaces, maintaining a linear design aesthetic, and maximizing space utilization.

While ideal for modern settings with straight lines and angles, such as corridors, hallways, and open-plan offices, they also fit well in traditional designs.

These sound clouds offer a dynamic visual element, focused sound absorption, and Class-A acoustic performance, enhancing sound quality and comfort

















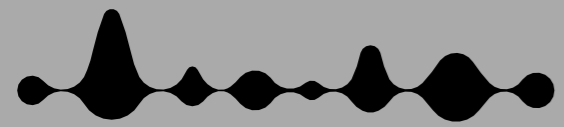

Dividers







## Dividers

Rotund L - Divider, Coleo L - Divider, Frame L - Divider & Oblong L - Divider

### Privacy in Quieter spaces

You can transform your spatial planning with our high-performance sound-absorbing room dividers.

These innovative solutions not only enhance acoustic comfort but also facilitate the creation of personal areas, allowing you to design private spaces tailored to your needs.

Experience a new level of functionality and tranquility in your environment.







# Rotund L - Divider

Sound-Absorbing Decorative Divider

Ø:1200mm x Thickness: 45mm H: 1300mm Base Ø: 400mm

## DIVIDER



# Rotund L - Divider

Sound-Absorbing Decorative Divider

Ø:1200mm x Thickness: 45mm H: 1300mm Base Ø: 400mm

## DIVIDER

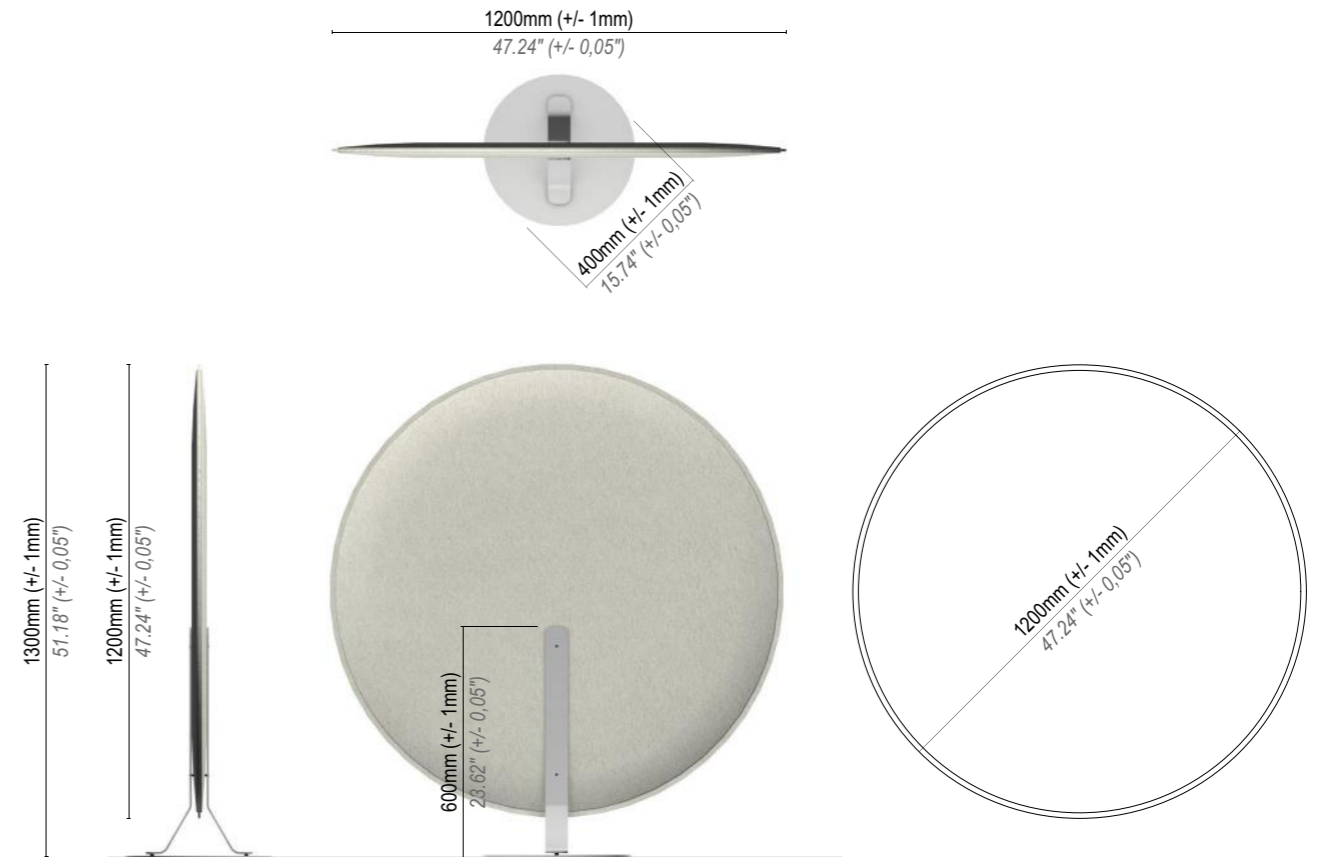

### APPLICATION

Divider - Indoor use only

### MATERIAL

Mechanical needled punch industrial felt.  
100% PET up to 60% Recycled content & Recyclable

### FIRE RATING

A Class (ASTM E84) - B s1 d0 (EN 13501-1)

### THERMAL INSULATION

0,035 W/mK

### WEIGHT

1 unit: 9000 gr. +/- 10% tolerance  
1 unit: 19.84 lbs with +/- 10% tolerance

### THICKNESS



Max. 45mm (+/- 2mm) - 1.77" (+/- 0.08")  
Min. 8mm (+/- 2mm) - 0.31" (+/- 0.08")

Smooth Surface - Impact Resistance - Flexible

### BOX SIZE & CONTENT

W: 1220 mm D: 1220 mm H: 120 mm  
W: 48.03" D: 48.03" H: 4.72"

1 Box: 2 x panels

1 Color of choice per package

Gross weight: 20 kg  
Gross weight: 44 lbs

### PRODUCT CODE / DESCRIPTION

### Box Qty

RLD-30BFN - Inherent Colors 2

RLD-30BFC - Color-IT 2

### Inherent Colors



### Color-IT Custom Colors



### PALETTE SIZE & CONTENT

W: 1220 mm D: 1015 mm H: 1400 mm  
W: 48" D: 40" H: 55"

8 Pcs. Box

Gross Weight  
180 kg  
396 lbs

W: 1200 mm D: 800 mm H: 1400 mm  
W: 47.25" D: 31.5" H: 55"

7 Pcs. Box

Gross Weight  
160 kg  
353 lbs

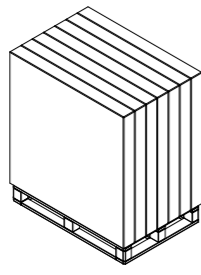
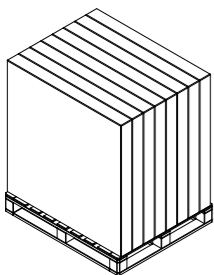

### ACOUSTIC PERFORMANCE

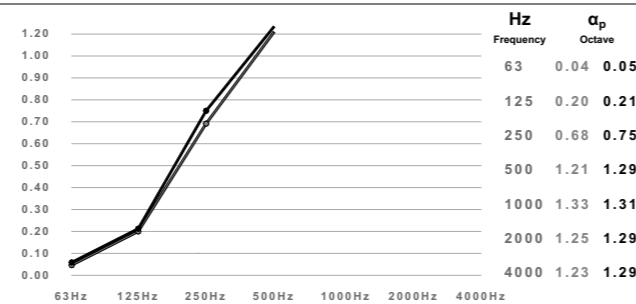

	$\alpha_w$	NRC	SAA	Class
Rotund Large	0.95	1.00	1.00	A
Distance to surface: 50mm	0.95	1.00	1.00	A
Distance to surface: 100mm	1.00	1.00	1.00	A

$\alpha_w$  Sound absorption coefficient according to ISO 354  $\alpha_p$  Practical sound absorption coefficient according to ISO 11654







# Coleo L - Divider

Sound-Absorbing Decorative Divider

1200mm x 1800mm Thickness: 45mm H: 1900mm Base Ø: 400mm

## DIVIDER



**APPLICATION**  
Wall & Ceiling - Indoor use only

**MATERIAL**  
Mechanical needled punch industrial felt.  
100% PET up to 60% Recycled content & Recyclable

**FIRE RATING**  
A Class (ASTM E84) - B s1 d0 (EN 13501-1)

**THERMAL INSULATION**  
0,035 W/mK

**WEIGHT**  
1 unit: 12.000 gr. +/- 10% tolerance  
1 unit: 26.45 lbs with +/- 10% tolerance

**THICKNESS**

Max. 45mm (+/- 2mm) - 1.77" (+/-0.08")  
Min. 8mm (+/- 2mm) - 0.31" (+/-0.08")

Smooth Surface - Impact Resistance - Flexible

**BOX SIZE & CONTENT**  
W: 1220 mm D: 1820 mm H: 120 mm  
W: 48.03" D: 71.65" H: 4.72"

**1 Box: 2 x panels**

**1 Color of choice per package**  
Gross weight: 27 kg  
Gross weight: 59.52 lbs

## PALETTE SIZE & CONTENT

W: 1220 mm D: 1015 mm H: 2000 mm  
W: 48" D: 40" H: 79"

**8 Pcs. Box**  
Gross Weight  
240 kg  
530 lbs

W: 1200 mm D: 800 mm H: 2000 mm  
W: 47.25" D: 31.5" H: 79"

**7 Pcs. Box**  
Gross Weight  
205 kg  
452 lbs

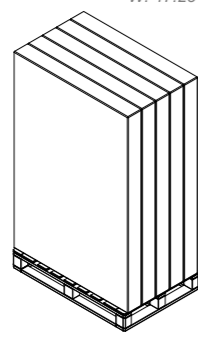
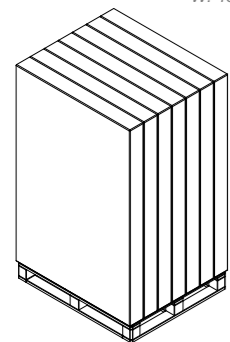

## ACOUSTIC PERFORMANCE

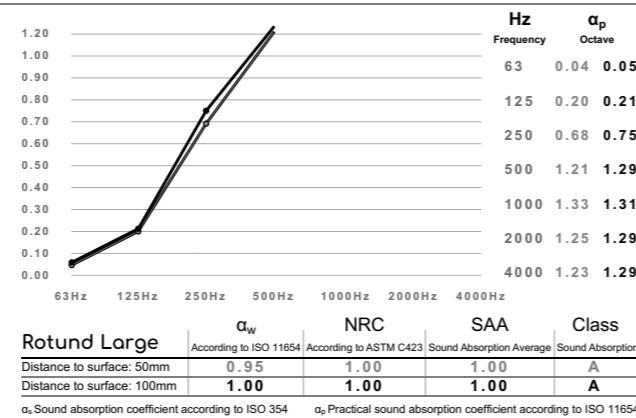

# Coleo L - Divider

Sound-Absorbing Decorative Divider

Ø:1200mm x Thickness: 45mm H: 1300mm Base Ø: 400mm

## DIVIDER

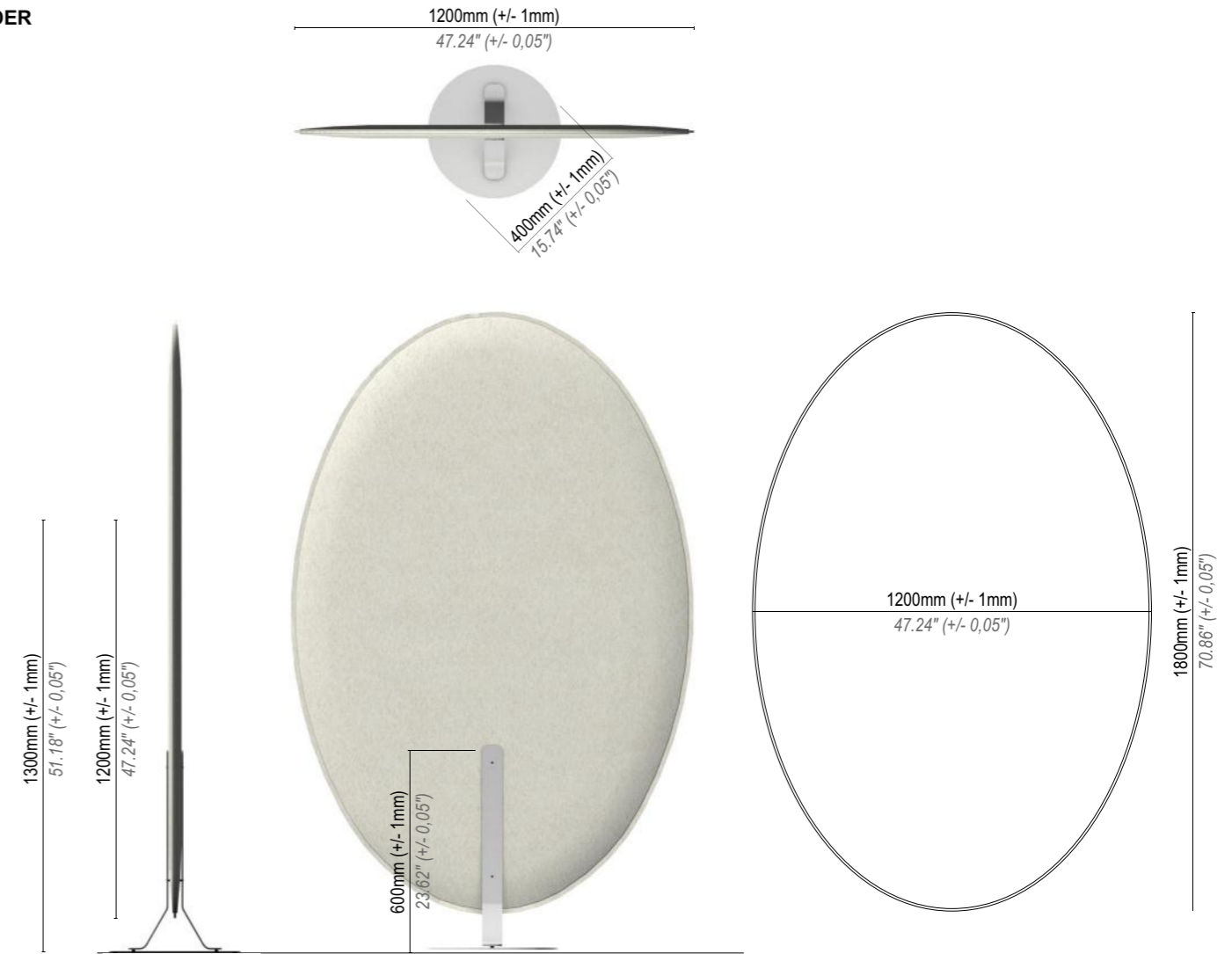

PRODUCT CODE / DESCRIPTION	Box Qty	Inherent Colors				Color-IT Custom Colors																	
		Color 1	Color 2	Color 3	Color 4	Color 5	Color 6	Color 7	Color 8	Color 9	Color 10	Color 11	Color 12										
CLD-30BFN - Inherent Colors	2	Pearl White	Mist	Dark Gray	Beige	Yellow	Green	Blue	Purple	Red	Orange	Black	White	Gray	Dark Gray	Light Gray	Dark Blue	Light Blue	Dark Green	Light Green	Dark Red	Light Red	
CLD-30BFC - Color-IT	2																						





# Frame L - Divider Sound-Absorbing Decorative Divider

1200mm x 1200mm Thickness: 45mm H: 1300mm Base: 120 x 400mm

# Frame L - Divider Sound-Absorbing Decorative Divider

1200mm x 1200mm Thickness: 45mm H: 1300mm Base: 120 x 400mm

## DIVIDER ON CASTERS

## DIVIDER ON LEGS

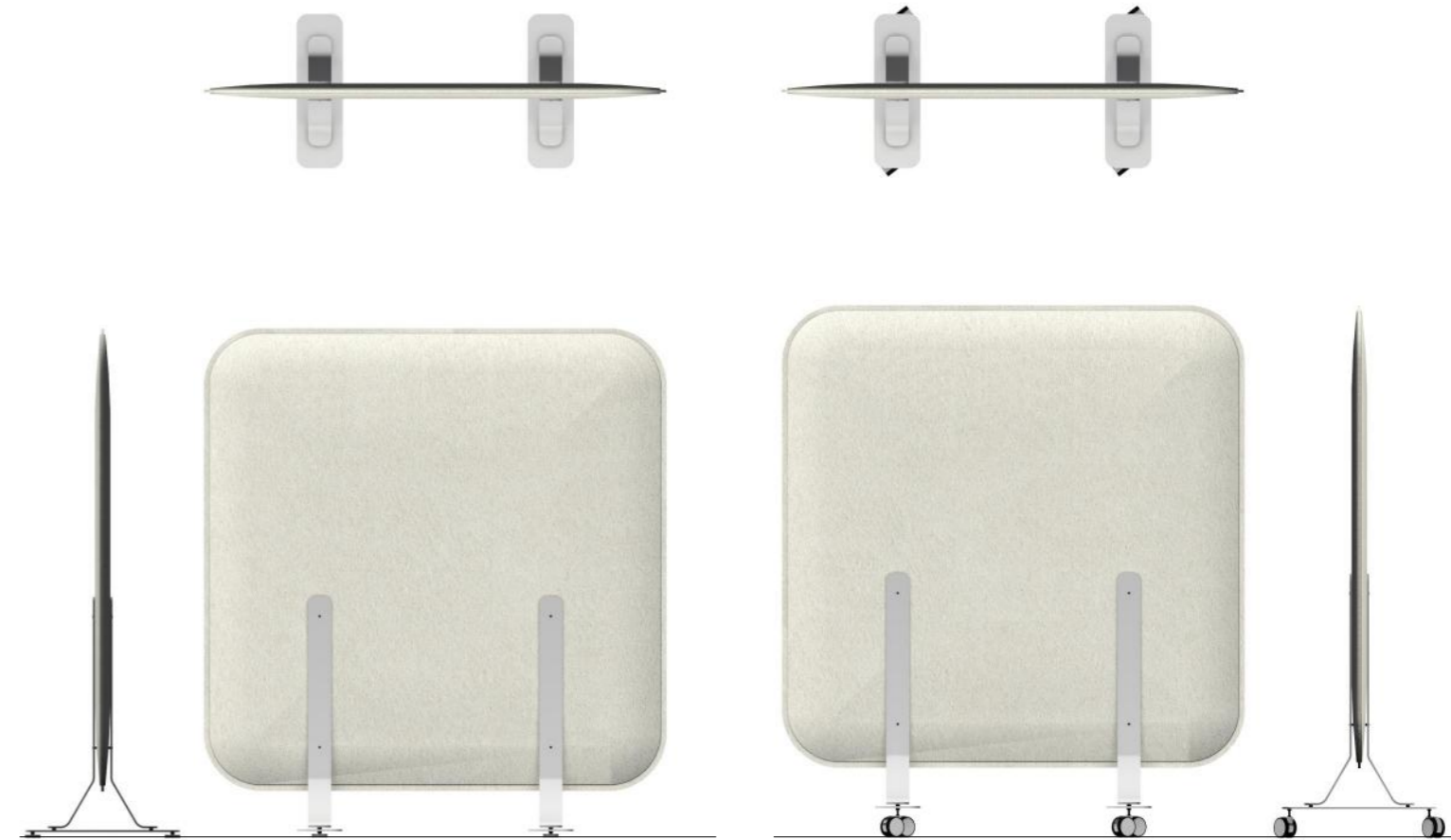

**APPLICATION**  
Wall & Ceiling - Indoor use only

**MATERIAL**  
Mechanical needled punch industrial felt.  
100% PET up to 60% Recycled content & Recyclable

**FIRE RATING**  
A Class (ASTM E84) - B s1 d0 (EN 13501-1)

**THERMAL INSULATION**  
0,035 W/mK

**WEIGHT**  
1 unit: 11.000 gr. +/- 10% tolerance  
1 unit: 24.25 lbs with +/- 10% tolerance

**THICKNESS**  
  
Max. 45mm (+/- 2mm) - 1.77" (+/- 0.08")  
Min. 8mm (+/- 2mm) - 0.31" (+/- 0.08")

Smooth Surface - Impact Resistance - Flexible

**BOX SIZE & CONTENT**  
W: 1220 mm D: 1220 mm H: 120 mm  
W: 48.03" D: 48.03" H: 4.72"

**1 Box: 2 x panels**  
**1 Color of choice per package**  
Gross weight: 25 kg  
Gross weight: 55.11 lbs

W: 1220 mm D: 1015 mm H: 1400 mm  
W: 48" D: 40" H: 55"

8 Pcs. Box

Gross Weight  
220 kg  
485 lbs

W: 1200 mm D: 800 mm H: 1400 mm  
W: 47.25" D: 31.5" H: 55"

7 Pcs. Box

Gross Weight  
190 kg  
420 lbs

### ACOUSTIC PERFORMANCE

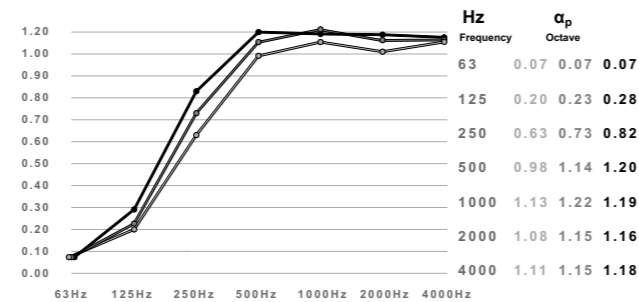

	$\alpha_w$	NRC	SAA	Class
Rotund Large	0.90	1.00	0.96	A
On the surface	0.90	1.00	0.96	A
Distance to surface: 50mm	1.00	1.00	1.00	A
Distance to surface: 100mm	1.00	1.00	1.00	A

$\alpha_w$  Sound absorption coefficient according to ISO 354  $\alpha_p$  Practical sound absorption coefficient according to ISO 11654

### Inherent Colors

### Color-IT Custom Colors

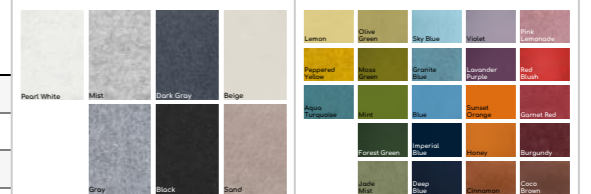

### PRODUCT CODE / DESCRIPTION

### Box Qty

FLD-30BPN - Inherent Colors	2
FLD-30BPC - Color-IT	2
FLD-30BCN - Inherent Colors + Casters	2
FLD-30BCC - Color-IT + Casters	2





# Oblong L - Divider Sound-Absorbing Decorative Divider

1200mm x 1800mm Thickness: 45mm H: 1900mm Base: 120 x 400mm

## DIVIDER ON CASTERS

## DIVIDER ON LEGS

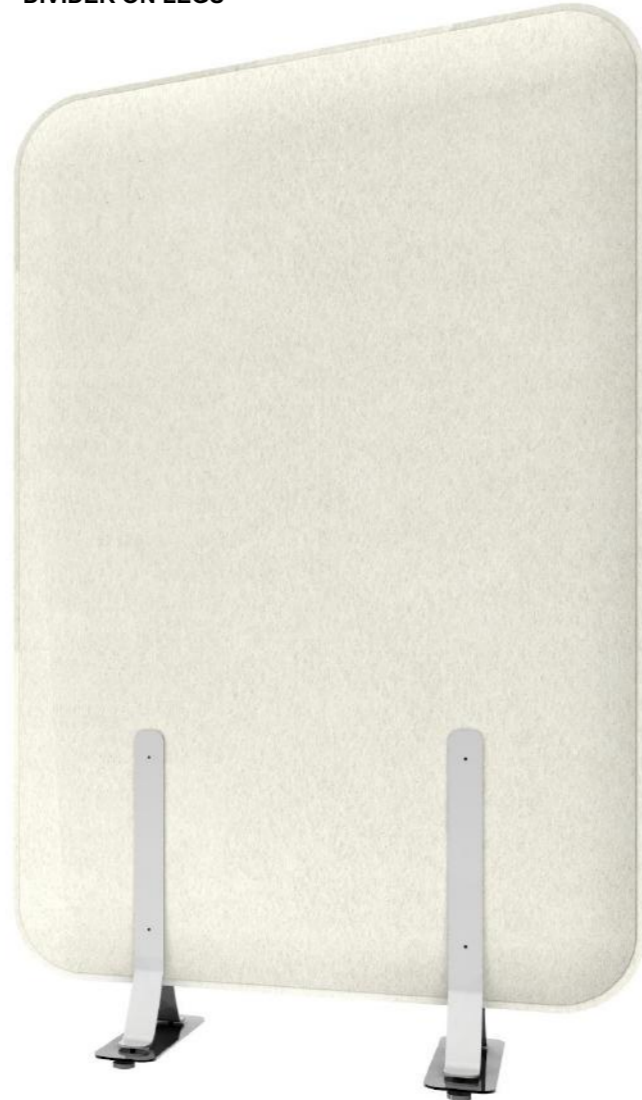
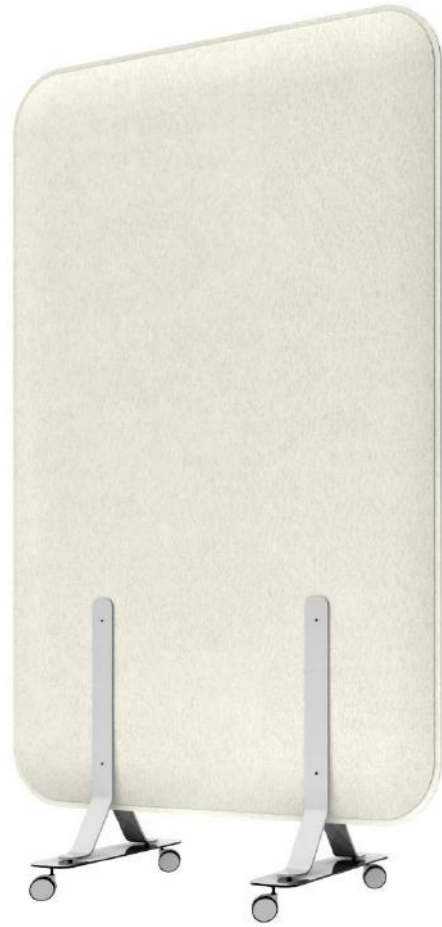

**APPLICATION**  
Wall & Ceiling - Indoor use only

**MATERIAL**  
Mechanical needled punch industrial felt.  
100% PET up to 60% Recycled content & Recyclable

**FIRE RATING**  
A Class (ASTM E84) - B s1 d0 (EN 13501-1)

**THERMAL INSULATION**  
0,035 W/mK

**WEIGHT**  
1 unit: 4500 gr. +/- 10% tolerance  
1 unit: 9.92 lbs with +/- 10% tolerance

**THICKNESS**

Max. 45mm (+/- 2mm) - 1.77" (+/- 0.08")  
Min. 8mm (+/- 2mm) - 0.31" (+/- 0.08")

Smooth Surface - Impact Resistance - Flexible

**BOX SIZE & CONTENT**  
W: 1220 mm D: 1220 mm H: 120 mm  
W: 48.03" D: 48.03" H: 4.72"

**1 Box: 2 x panels**  
1 Box: 2.842 m<sup>2</sup>  
1 Box: 30.591 ft<sup>2</sup>

**1 Color of choice per package**  
Gross weight: 12 kg  
Gross weight: 26.45 lbs

W: 1220 mm D: 1015 mm H: 1400 mm  
W: 48" D: 40" H: 55"

W: 1200 mm D: 800 mm H: 1400 mm  
W: 47.25" D: 31.5" H: 55"

**8 Pcs. Box**  
Gross Weight  
**110 kg**  
242 lbs

**7 Pcs. Box**  
Gross Weight  
**95 kg**  
210 lbs

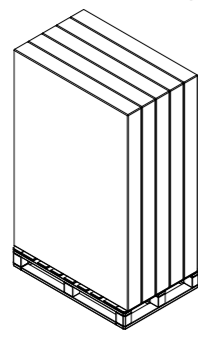
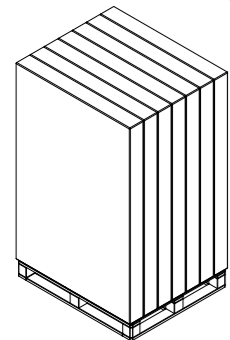

### ACOUSTIC PERFORMANCE

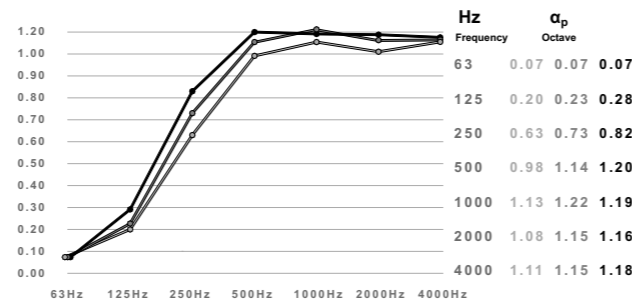

	$\alpha_w$	NRC	SAA	Class
	According to ISO 11654	According to ASTM C423	Sound Absorption Average	Sound Absorption
Rotund Large	0.90	1.00	0.96	A
On the surface	1.00	1.00	1.00	A
Distance to surface: 50mm	1.00	1.00	1.00	A
Distance to surface: 100mm	1.00	1.00	1.00	A

$\alpha_w$  Sound absorption coefficient according to ISO 354  $\alpha_p$  Practical sound absorption coefficient according to ISO 11654

# Oblong L - Divider Sound-Absorbing Decorative Divider

1200mm x 1800mm Thickness: 45mm H: 1900mm Base: 120 x 400mm

## DIVIDER

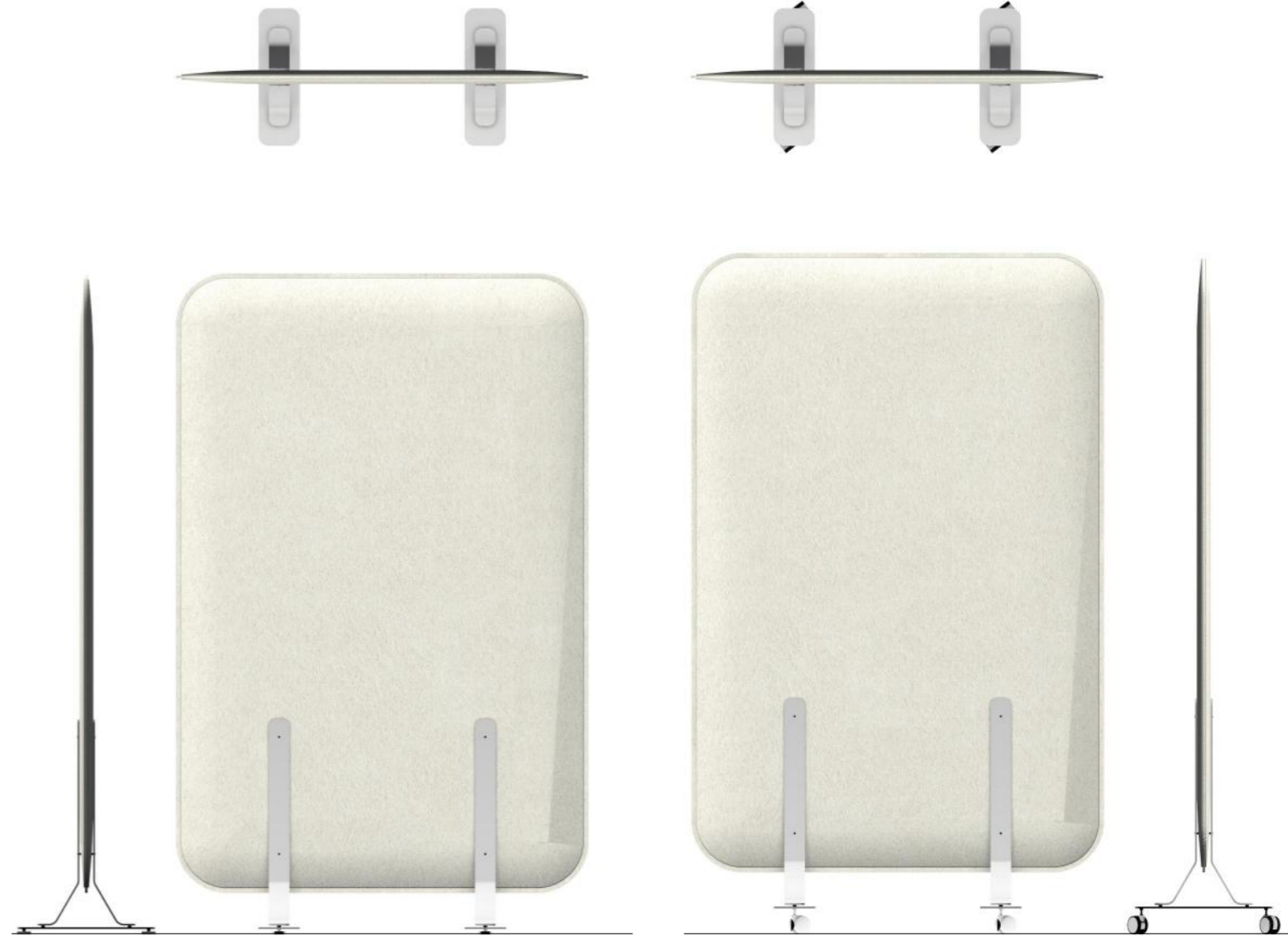

PRODUCT CODE / DESCRIPTION	Box Qty	Inherent Colors				Color-IT Custom Colors												
		Pearl White	Mid	Dark Gray	Beige	Yellow	Orange	Red	Pink	Purple	Blue	Green	Black	White	Gray	Dark Gray	Black	
OLD-30BPN - Inherent Colors	2																	
OLD-30BPC - Color-IT	2																	
OLD-30BCN - Inherent Colors + Casters	2																	
OLD-30BCC - Color-IT + Casters	2																	





# Inherent Colors



The colors displayed in this palette may not accurately represent their true appearance on screen.

# Color-IT





The colors displayed in this palette may not accurately represent their true appearance on screen.









USA Office Europe Office Turkiye Office

 <p><b>Address</b> 16180 Aberdeen Ave Naples, FL 34110 - USA</p>	 <p><b>Email Address</b> usa@acoustit.com <a href="#">SEND MESSAGE →</a></p>	 <p><b>Phone</b> <a href="#">CALL ANYTIME →</a></p>
-----------------------------------------------------------------------------------------------------------------------------------------------------------	-----------------------------------------------------------------------------------------------------------------------------------------------------------------------	--------------------------------------------------------------------------------------------------------------------------------------------

USA Office Europe Office Turkiye Office

 <p><b>Authorized Distributor</b> c/o Derici &amp; Company GmbH Sumpfstrasse 18 Steinhausen 6312 - Switzerland</p>	 <p><b>Email Address</b> switzerland@acoustit.com <a href="#">SEND MESSAGE →</a></p>	 <p><b>Phone</b> <a href="#">CALL ANYTIME →</a></p>
-----------------------------------------------------------------------------------------------------------------------------------------------------------------------------------------------------------------	-------------------------------------------------------------------------------------------------------------------------------------------------------------------------------	--------------------------------------------------------------------------------------------------------------------------------------------

USA Office Europe Office Turkiye Office

 <p><b>Authorized Distributor</b> Baf Control Atalar Mah. Çanakkale Cad. No:31/4 Kartal - İstanbul/Turkiye</p>	 <p><b>Email Address</b> info@bafcontrol.com <a href="#">SEND MESSAGE →</a></p>	 <p><b>Phone</b> +90 (216) 353 5363 <a href="#">CALL ANYTIME →</a></p>
---------------------------------------------------------------------------------------------------------------------------------------------------------------------------------------------------------------	----------------------------------------------------------------------------------------------------------------------------------------------------------------------------	---------------------------------------------------------------------------------------------------------------------------------------------------------------------



www.acoustit.com

**General Inquiries**  
info@acoustit.com

**Europe**  
switzerland@acoustit.com

**Americas**  
usa@acoustit.com

**Middle East & Asia**  
turkiye@acoustit.com

