

Blade Small

Cutting Through Noise

'Blade' sound bages are designed to provide superior acoustic management by effectively reducing noise and reverberation in large, open spaces. Suspended vertically from the ceiling, these bages are perfect for use in areas such as offices, auditoriums, and conference rooms. With easy installation and customizable options, Blade sound bages offer a practical and stylish solution for creating quieter, more comfortable spaces.



Blade Small

Sound-Absorbing Decorative Ceiling Pendant & Wall Panel

300mm x 900mm x 20mm

APPLICATION

Wall with hook & loop 4x per unit

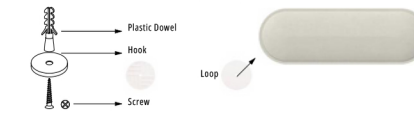

Ceiling with hanging wires 2x per unit

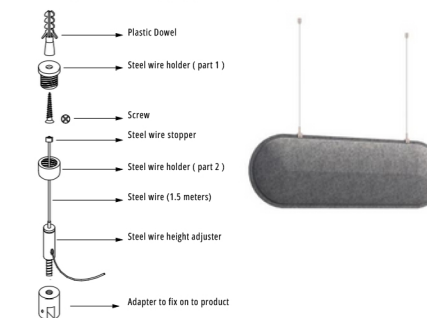

Module with metal carrier & hanging wires



MATERIAL

Mechanical needled punch industrial felt.
100% PET up to 60% Recycled content & Recyclable
Smooth Surface - Impact Resistance - Flexible

FIRE RATING

A Class (ASTM E84) - B s1 d0 (EN 13501-1)

THERMAL INSULATION

0,035 W/mK

WEIGHT

1 tile: 565 gr. +/- 10% tolerance
1 tile: 1.24 lbs with +/- 10% tolerance

THICKNESS



Max. 20mm (+/- 2mm) - 0.78" (+/- 0.08")
Min. 5mm (+/- 2mm) - 0.19" (+/- 0.08")

BOX SIZE & CONTENT

W: 920 mm D: 920 mm H: 120 mm
W: 36.22" D: 36.22" H: 4.72"

1 Box: 12 x panels
1 Box: 3.012 m²

1 Box: 34.421 ft²
1 Color of choice per package

Gross weight: 8.0 kg
Gross weight: 17.63 lbs

PALETTE SIZE & CONTENT

W: 1220 mm D: 1015 mm H: 2150 mm
W: 48" D: 40" H: 84.5"
20 Pcs. Box

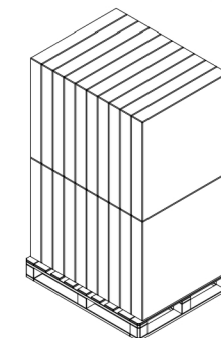

Gross Weight
180 kg
396 lbs

W: 1200 mm D: 800 mm H: 2150 mm
W: 47.25" D: 31.5" H: 84.5"
12 Pcs. Box

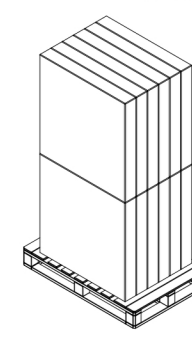

Gross Weight
115 kg
254 lbs



ACOUSTIC PERFORMANCE

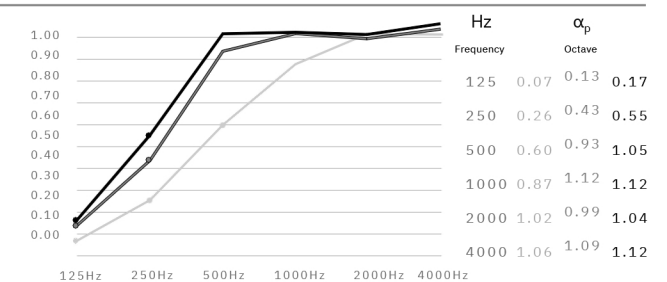

	alpha_w	NRC	SAA	Class
Blade Small	0.55	0.70	0.69	D
On the surface	0.70	0.90	0.88	C
Distance to surface: 50mm	0.85	1.00	0.94	B
Distance to surface: 100mm				

as Sound absorption coefficient according to ISO 354
alpha_p Practical sound absorption coefficient according to ISO 11654



Blade Small

Sound-Absorbing Decorative Ceiling Pendant & Wall Panel

300mm x 900mm x 20mm

WALL



Detachable Hook&Loop Patches

		Inherent Colors	Color-IT Colors	Hook & Loop
PRODUCT CODE / DESCRIPTION	Box Qty / m2			
BSW-30AAN - Inherent Colors (Panel Only)	12 / 3.01 m2			
BSW-30VCN - Inherent Colors + Hook & Loop	12 / 3.01 m2			
BSW-30AAC - Color-IT (Panel Only)	12 / 3.01 m2			
BSW-30PSC - Color-IT + Hook & Loop	12 / 3.01 m2			

CEILING

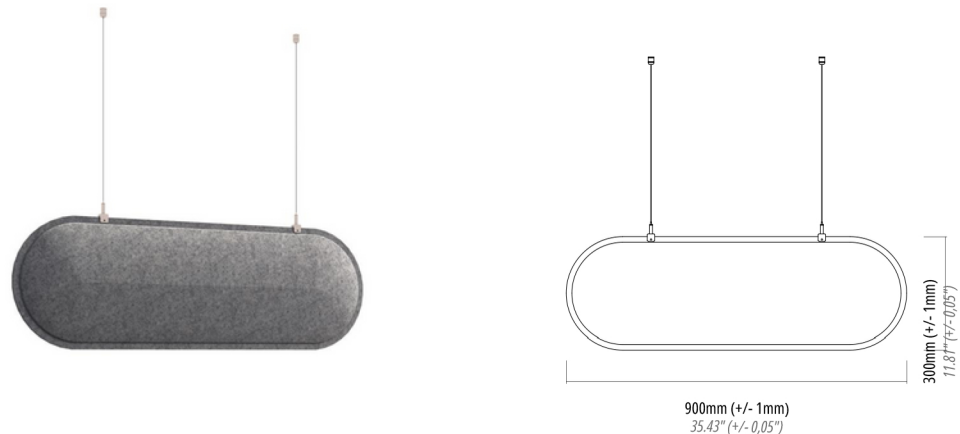

		Inherent Colors	Color-IT Colors	Hanging Set
PRODUCT CODE / DESCRIPTION	Box Qty / m2			
BSH-20HSN - Inherent Colors + Hanging Set	12 / 3.01 m2			
BSH-20HSC - Color-IT + Hanging Set	12 / 3.01 m2			

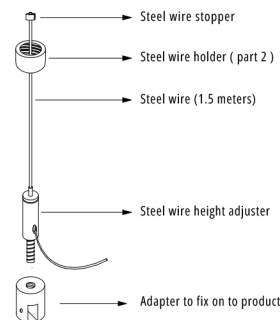

CEILING MODULE

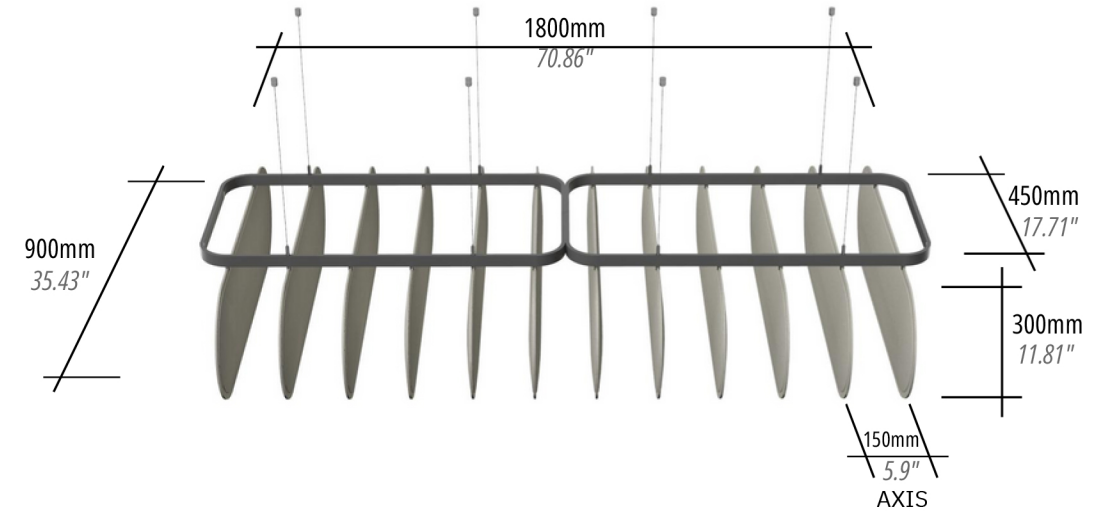
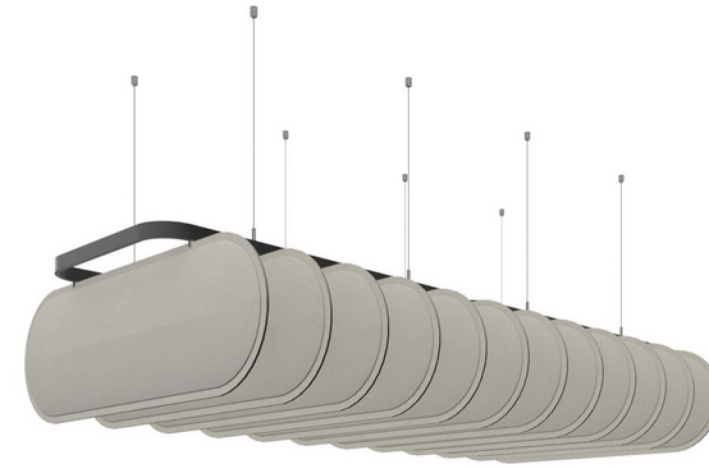

		Inherent Colors	Color-IT Colors	Carrier System & Hangers
PRODUCT CODE / DESCRIPTION	Box Qty / m2			
BSM-20HSN - Inherent Colors + Hanging Set	12 / 3.01 m2			
BSM-20HSC - Color-IT + Hanging Set	12 / 3.01 m2			

